

STANDARD Professional

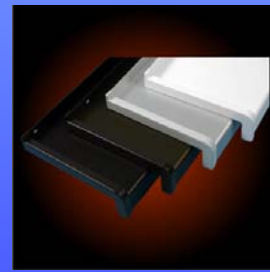

R.S.P. s.r.o.



ZÁKLADNÍ INFORMACE

Hliník

Nerez

Mosaz

Plast

VZORKOVNÍK BAREV	3-4		
VŠEOBECNÉ PODMÍNKY	5		
REKLAMAČNÍ ŘÁD	6		
GARANCE FUNKČNOSTI	7		
POUŽITELNOST KOVÁNÍ HOPPE	8		
RYCHLOČTYŘHRAN HOPPE	9		
URČENÍ STRANY OTEVÍRÁNÍ	10		
MATERIÁL, POVRCH A ÚDRŽBA	11		
RESISTA	12		
SECUSTIK	13		
BEZPEČNOSTNÍ KOVÁNÍ	14		
UPEVNĚNÍ MADEL	15		



ZÁKLADNÍ INFORMACE - VZORKOVNÍK BAREVNÝCH PROVEDENÍ
Hliník
Nerez
Mosaz
Plast

F1 - Elox přírodní



F1-2 - Elox přírodní matný



F1/F69 - Elox přírodní/ nerez matná



F2 - Elox alpaka



F4 - Elox bronz



F9 - Elox ocel



F9-2 - Elox ocel matná



F8019 - Šedohnědá barva



F8707 - Tmavohnědá barva lesklá



F9016 - Bílá barva



F69 - Nerez matná



F69/F68 - Nerez matná/ nerez lesklá



F41 - Chrom satinovaný



F41-R - Chrom satinovaný-Resista®



F45-R - Chrom satinovaný/ chrom-Resista®



F46-R - Chrom satinovaný/ chrom-Resista®



F49 - Chrom



F49-R - Chrom-Resista®



F49/F9 - Chrom/ elox ocel



F49/F69 - Chrom/ nerez matná





R.S.P. s.r.o.

ZÁKLADNÍ INFORMACE - VZORKOVNÍK BAREVNÝCH PROVEDENÍ

Hliník

Nerez

Mosaz

Plast



F49-R/F98-R - Chrom/ chrom matný- **Resista**®



F54 - Antika



F55 - Antika brynýr



F56 - Antika stříbrná



F65-R - Nikl satinovaný/ nikl lesklý- **Resista**®



F71 - Mosaz lesklá



F71/F49 - Mosaz lesklá/ chrom



F71/F9708 - Mosaz lesklá/ bílá barva



F71/H02 - Mosaz lesklá/ buk tmavý



F71/H03 - Mosaz lesklá/ buk světlý



F71/H04 - Mosaz lesklá/ buk bělený



F72/F9 - Mosaz/ elox ocel



F72/F69 - Mosaz matná/ nerez matná



F73 - Mosaz brynýrovaná



F74-R - Mosaz satinovaná/ lesklá- **Resista**®



F75-R - Mosaz lesklá/ satinovaná- **Resista**®



F76 - Antika brynýrovaná patina



F77-R - Mosaz lesklá- **Resista**®



F98/H07 - Chrom matný/ buk



F98-R - Chrom matný- **Resista**®

© R.S.P. s.r.o. Týn nad Vltavou

Verze: HOP-SP-06.14



Platnost od: 15.03.2014

Tisk: 01.03.2014

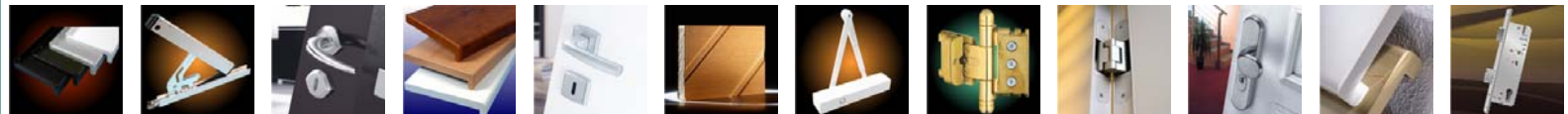
Technické změny vyhrazeny!



ZÁKLADNÍ INFORMACE - VŠEOBECNÉ PODMÍNKY
Hliník
Nerez
Mosaz
Plast

Sklad		Skladem - termín dodání obvykle obratem Barevné provedení je naskladněno na základě standardní nabídky nebo dle smluvních odběrů pro konkrétního odběratele
		Skladem na dotaz - termín dodání dle skladových možností Barevné provedení je naskladněno na minimální výši celého balení nebo dle smluvních odběrů pro konkrétního odběratele.
		K objednávce - termín dodání dle výrobních a dodacích možností výrobce Barevné provedení je určeno pro individuální objednávku.
Dodací podmínky	Pokud se jedná o barevné provedení, u kterého je dočasně snížena skladová zásoba, která je způsobena zvýšenou poptávkou, dodací lhůta je prodloužena - dle výrobních a dodacích možností výrobce. Ceny nezahrnují náklady spojené s přepravou k odběrateli. V případě dodávky zboží v ceně nad 20.000 Kč bez DPH není doprava odběrateli účtována.	
Ceny a slevy	Ceny v katalogu jsou uvedeny bez DPH za jednotku. Na tyto ceny je možno poskytnout individuální slevy a to za dodržení podmínek: pravidelné odběry, platební kázeň a uzavření „Rámcové kupní smlouvy“.	
Přepavní podmínky	Pokud si zákazník nemůže zboží odebrat sám a nemá smlouveny obchodní podmínky „Rámcovou kupní smlouvu“, je standardně dopraveno dle všeobecných přepravních a cenových podmínek služeb České pošty a společností Toptrans a PPL. Pokud zákazník má domluveny individuální přepravní podmínky, jsou mu ceny účtovány za podmínek „Rámcové kupní smlouvy“.	
Platební podmínky	Platba při jednorázovém odběru je vždy zálohově nebo v hotovosti. V případě smluvního odběru, tj. při uzavření „Rámcové kupní smlouvy“ jsou poskytnuty obchodní podmínky a ty dále závazné po dobu trvání obchodního vztahu a platnosti uzavřené smlouvy. V případě neuhrazení faktur ve splatnosti si vyhrazujeme právo vést taková opatření, která povedou k nápravě nedodržení obchodních případů.	
Kontakt	R.S.P. s.r.o.	IČ: 25073028
	Nádražní 165	DIČ: CZ25073028
	375 01 Týn nad Vltavou	Bankovní spojení: ČSOB a.s.
	Telefon: 385 731 803	Číslo účtu: 162972478/0300
	385 721 211	E-mail: prodej@rsp.cz
	Fax: 385 731 702	poptavky@rsp.cz
	GSM Brána: 608 103 067-8	Internet: www.rsp.cz
Společnost je zapsána v OR u Městského soudu v Praze, oddíl C, vložka 47293		





R.S.P. s.r.o.

ZÁKLADNÍ INFORMACE - REKLAMAČNÍ ŘÁD

Hliník

Nerez

Mosaz

Plast

Reklamační řád

R.S.P. s.r.o. se sídlem Zenklova 168, 180 00 Praha 8

IČ: 25073028, DIČ: CZ25073028, Zapsané v OR u Městského soudu v Praze v oddílu C, vložce 47293 (dále jen „prodávající“)

Reklamační řád byl vypracován v souladu s českým právním řádem, zejména zák. č.513/1991 Sb., Obchodním zákoníkem a dalšími obecně závaznými právními předpisy. Kupující převzetím zboží od prodávajícího nebo přepravce souhlasí s tímto uvedeným reklamačním řádem.

1. Zboží je prodávajícím dodáváno v kvalitě podle platných norem jednotlivých výrobců i dodavatelů prodávajícího. Platí, že odchylky zboží, jedná-li se pouze o drobné rozdíly a odchylky v jakosti či provedení, které nemají vliv na možnost zboží užívat, nejsou vadami. Prodávající se zavazuje expedovat zboží tak, aby bylo zabaleno do vhodného obalového materiálu vyhovujícího nárokům přepravy daného zboží a předejít tak nebezpečí možného poškození zboží během přepravy.

2. Kupující je povinen prohlédnout zboží bezprostředně při jeho převzetí, a to takovým způsobem, aby mohl zjistit při vynaložení veškeré odborné péče vady zboží.

3. Pokud je zjištěno mechanické poškození obalu výrobku, je kupující povinen o tomto vyhotovit záznam o poškození za přítomnosti osoby, jež provedla dopravu. Odpovědnost za poškození v průběhu přepravy nese dopravce, veškeré zboží je pojištěno. Na základě vyhotoveného výše uvedeného zápisu o poškození obalu je na dopravci požadována přiměřená náhrada za poškození zboží v důsledku přepravy.

4. Kupující přebírá dodané zboží na základě dodacího listu. Jeho podepsáním pak souhlasí s tím, že zboží bylo dodáno bez zjevných vad, že zboží nebylo mechanicky poškozeno a že bylo dodáno v množství deklarovaném v dodacím listu. Veškeré tyto skutečnosti je třeba ověřit a písemně uplatnit při podpisu dodacího listu, když na pozdější reklamace nemůže být brán a nebude brán zřetel.

5. Kupující je povinen podat prodejci zprávu o vadách zboží a uplatnit konkrétní nárok z odpovědnosti za vady ve lhůtě tří dnů poté, kdy a) vady zjistil, b) při vynaložení veškeré odborné péče měl vady zjistit při prohlídce, jež je povinen uskutečnit podle § 427 odst. 1, 2 obchod. zák. nebo c) vady mohly být zjištěny při vynaložení veškeré odborné péče, nejpozději však do dvou let od doby dodání zboží, popřípadě od dojití zboží do místa určení stanoveného ve smlouvě.

6. V případě, kdy bude kupující požadovat dodání nového bezvadného zboží před vrácením reklamovaného nebo před ukončením reklamačního řízení, bude prodávající toto zboží účtovat. V případě kladného vyřízení reklamace bude následně vystaven dobropis.

7. Prodávající poskytuje záruku na zboží, když délka záruky činí 24 měsíců.

8. V případě uplatnění reklamace si kupující ve vlastním zájmu počíná tak, aby bylo zboží zabaleno do vhodného obalu vyhovujícímu nárokům přepravy daného zboží a to z důvodu nebezpečí možného poškození zboží.

9. V případě, kdy prodávající neobdržel reklamované zboží do 14 dnů od uplatnění reklamace, je tato reklamace považována za bezpředmětnou a kupujícímu nenáleží práva, kterých se takovouto reklamací domáhal.

10. Lhůty stanovené pro notifikaci v čl. 6 i lhůty stanovené pro předání zboží v čl. 10 je třeba zachovat i v případě uplatňování práv ze záruky za zboží, když však notifikace musí být učiněna nejpozději do konce záruční doby.

11. Kupující má nárok na odstranění vad nebo na slevu z kupní ceny.

12. Prodávající bez zbytečného odkladu po obdržení reklamace a reklamovaného zboží reklamaci vyřídí. Reklamace je zpravidla vyřízena do 30 dnů od převzetí reklamovaného zboží.

13. Prodávající je oprávněn požadovat náhradu nákladů za vyřízení neoprávněné reklamace, když tato částka se stanovuje paušálně ve výši 500,- Kč.

Tento reklamační řád nabývá účinnosti dnem 1.10.2006 a je závazný jako obchodní podmínky ve smyslu § 273 obchodního zákoníku.

V Týně nad Vltavou dne 15. září 2006

© R.S.P. s.r.o. Týn nad Vltavou

Verze: HOP-SP-06.14

Platnost od: 15.03.2014

Tisk: 01.03.2014

Technické změny vyhrazeny!

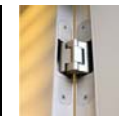
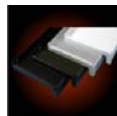



ZÁKLADNÍ INFORMACE - GARANCE FUNKČNOSTI

Hliník

Nerez

Mosaz

Plast



10-ti letá záruka funkčnosti na všechny okenní a dveřní kliky HOPPE



Garance funkčnosti

Prohlášení o záruce:

Nad rámec záruky prodejce za vady poskytujeme za následujících předpokladů a v následně vymezeném rozsahu záruku odolnosti kování. Jako výrobce garantujeme bezchybnou funkčnost dveřních a okenních kování HOPPE při přiměřeném používání.

Záruka se vztahuje na následující funkce:

- přenos otáčivého pohybu na dveřní zámek nebo na okenní otevíravě-sklopné kování
- uzamykací mechanismus (u okenních klik se zvláštními funkcemi: uzamykací samočinné zajištění Secustik®)

Záruka se nevztahuje:

- na všechny vyměnitelné součásti, např. šrouby, čtyřhrany, atd..

Kromě toho se záruka dále nevztahuje na škody vzniklé -

- nevhodným a nepřiměřeným používáním
- nesprávným a nedbalým zacházením
- nedodržením návodu na montáž a údržbu, vlastními zásahy a opravami
- chemickým a fyzikálním působením na povrch, mimo běžné použití, např. poškození ostrými předměty
- vadné stavební díly (dveře, okna) a součástí kování (např. zámek, dveřní závěs, atd.).

Podmínky záruky:

Poskytnutí záruky spočívá výhradně v tom, že v případě, vyskytne-li se během naší záruční lhůty funkční vada na kování HOPPE, provedeme dle našeho uvážení prvnímu konečnému spotřebiteli bezplatnou opravu výrobku nebo bezplatně dodáme stejné nebo jiné odpovídající kování. Ostatní náklady s tímto vzniklé, jako např. cestovné, poštovné, apod. nebudou hrazeny. Nárok na uplatnění záruky vzniká pouze po předložení výrobku a dokladu, že vada na povrchu vznikla v průběhu záruční lhůty. Tímto dokladem je především účtenka s nákupní cenou, proto doporučujeme uchovat tento doklad nejméně do vypršení záruční lhůty.

Záruční lhůta:

Záruční lhůta činí 10 let a začíná dnem nákupu prvním konečným spotřebitelem. Při reklamaci se obraťte prosím s výrobkem a odpovídající účtenkou přímo na prodejce nebo výrobce.

HOPPE Holding AG
Via Friedrich Hoppe
CH-7537 Münstair



Nový standard kvality značkového kování HOPPE



© R.S.P. s.r.o. Týn nad Vltavou

Verze: HOP-SP-06.14

Platnost od: 15.03.2014

Tisk: 01.03.2014

Technické změny vyhrazeny!





R.S.P. s.r.o.

ZÁKLADNÍ INFORMACE - POUŽITELNOST KOVÁNÍ HOPPE

Hliník

Nerez

Mosaz

Plast

1. Informace o výrobku a jeho použití
2. Chybné použití
3. Údržba výrobku
4. Použití druhově podobných variant

1. Informace o výrobku a jeho použití

Systémy **HOPPE** kování jsou ovládací prvky, jejichž pomocí lze otevírat a zavírat, případně zajišťovat vchodové dveře, balkónové dveře a okna v pozemní a bytové výstavbě.

Běžně se používají společně s doplňujícími součástmi kování jako jsou dveřní zámky, profilové cylindrické vložky nebo otvíravé a sklopné kování.

Musí být respektovány závazné předpisy, například protipožární uzávěr - správné a úplné umístění všech ovládacích prvků nutných pro bezproblémový chod z protipožárního hlediska - viz správné umístění jednostranně ovládaných kování (madlo/ klika) ve směru úniku.

Bezpodmínečně je třeba používat s kováním dodávané připevňovací a montážní prvky a dodržovat přiložené montážní návody.

Toto platí zejména pro:

- a) připevňovací prvky vlastní výroby firmy **HOPPE**
- b) montážní prvky vlastní výroby firmy **HOPPE**
- c) zabezpečovací prvky vlastní výroby firmy **HOPPE**
- d) výše uvedené prvky spolu s montážními návody jiných výrobců, s jejichž výrobky se **HOPPE** kování používá.

Výrobky, které mají být použity:

- v prostředí se zvýšeným zajištěním ochrany a bezpečnosti uživatelů,
- v agresivním a korozi podporujícím prostředí

jsou zvláštní druhy kování, jejich použití by se mělo přikročit jen po konzultaci s odborníky pověřenými firmou **HOPPE**.

2. Chybné použití

O chybné použití, tj. o použití kování pro dveře a okna v rozporu s jejich určením, se jedná zejména tehdy, jestliže:

- ovládání se provádí pomocnými nástroji (např. kleštěmi, nebo různými trubkovými nástavci),

- dochází k předávnému zatížení (např. nosné a opěrné síly) - např. umístěním nějakého předmětu pod dveřní kliku pro její zablokování,

- na kliku působí síly překračující normální sílu ruky (např. při pokusu o překonání blokování otvíravě-sklopného kování vynaložením zvýšené síly,

- se kombinují prvky od jiných výrobců, případně prvky nestejného určení,

- se provádějí neodborné zásahy nebo úpravy, které následně ovlivňují funkci výrobku,

- se ostrými předměty poškozují povrch.

3. Údržba výrobku

Je třeba dbát na dokonalé funkční usazení dílů kování a připevňovacích prvků.

U všech pohyblivých částí je potřeba nejméně jednou ročně (dle četnosti použití) provést údržbu promazáním mazacím tukem a minerálním olejem, popř. seřízení a utažení všech povolených částí kování.

Značková **HOPPE** kování jsou vyráběna z vybraných materiálů. Díly kování z hliníku a z mosazi jsou vyráběny pouze z kvalitních nepřetavovaných legur.

Díly kování z ušlechtilé oceli tj. nerez jest materiál s vynikající odolností vůči korozi a kyselinám.

Naproti těmto skutečnostem je nutno chránit díly kování z hliníku před znečištěním maltou, vápennou suspenzí a podobnými materiály, které by měly za následek trvalé poškození jak vnitřních pohybových mechanismů tak pohledových ploch hliníkových dílů zejména eloxovaných.

Povrch mosazných dílů kování je chráněn transparentním vypalovacím lakem s dobrou přilnavostí a vysokou odolností vůči rozpouštědlům a chemikáliím. Přesto může dojít k poškození ochranné vrstvy klíči, prstýnky, ostrými předměty, apod., ovšem bez následného rozpadu struktury mosazi.

Vždy u všech druhů kování a možných povrchových úprav je nutno používat jen takové čisticí prostředky, které neobsahují žádné zdrsňující složky.

4. Použití druhově podobných variant

Na možné varianty jednotlivých systémů kování a jejich příslušenství je třeba informace o výrobku a použití přiměřeném jeho určení, chybném použití, parametrech výrobku, údržbě výrobku a povinnosti poskytování informací a instrukcí aplikovat analogicky podle jejich shodných znaků.

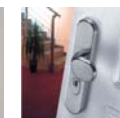
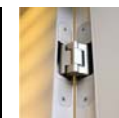
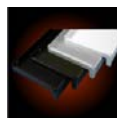

ZÁKLADNÍ INFORMACE - GARANCE FUNKČNOSTI

Hliník

Nerez

Mosaz

Plast



Čas jsou peníze.

Moderní a nadčasová konstrukce interiérových klik.

Při montáži běžné interiérové kliky je nutné provést několik kroků, které vedou k opakující manipulaci s výrobkem. I při nejšetrnějším zacházení vždy hrozí nevratné poškození povrchu montážními nástroji. Tyto problémy do určité míry řeší HOPPE rychločtyřhran - revoluční konstrukce interiérových klik.

Základem této nové techniky je v HOPPE vyvinutý upínací mechanismus, který je umístěn v samostatné klice. Tento mechanismus upne plný čtyřhran protilehlého dílu kliky s pevně nalisovaným čtyřhranem a přichytí jej trvale a bez nežádoucí vůle. Díky použití plného čtyřhranu je využit celý průřez čtyřhranu k přenesení maximálního krouťícího momentu. Rychločtyřhran HOPPE je bezstupňové axiální spojení dveřních klik přezkoušené podle DIN EN 1906, které je možné požit pro různé (v definovaném rozmezí) tloušťky dveří.



Sesadit dohromady
- hotovo!

Přednosti nového čtyřhranu pro rychlé upevnění:

- velmi rychlé upevnění kliky: **75% úspora** času
- žádný pojistný červík nebo příčný kolík
 - žádný otvor se závitem
 - žádné axiální srovnávání čtyřhranu při spojování s klikou
 - žádné samovolné vypadnutí červíku nebo příčného kolíku
- integrovaný upínací mechanismus ve volné klice
 - žádné nářadí na montáž klik
 - spojení dveřních klik bez vůle
 - dlouhodobě jistá fixace dveřních klik
- užití plného čtyřhranu
 - využití celého průřezu čtyřhranu k přenesení maximálního krouťícího momentu
- bezstupňové axiální spojení dveřních klik přezkoušené podle DIN EN 1906
 - možno použít plynule pro různé tloušťky dveří (v definovaném rozmezí)
- lehká a rychlá demontáž dveřních klik
 - např. s přiloženým úhlovým klíčkem nebo úzkým plochým šroubovákem



Důležité:

Produkty HOPPE s rychločtyřhranem nesmějí být kombinovány s plnými čtyřhrany od jiných výrobců!

Více informací k rychločtyřhranu HOPPE naleznete zde na této stránce nebo v prezentačním videu na DVD. V případě Vašich dalších dotazů nás prosím kontaktujte.





R.S.P. s.r.o.

ZÁKLADNÍ INFORMACE - URČENÍ STRANY OTEVÍRÁNÍ

Hliník

Nerez

Mosaz

Plast

Abychom stanovili, zda jsou dveře dle DIN levé nebo pravé, musíme především dát pozor na to, kde se závěsy nacházejí a to vždy při pohledu na stranu dveří s viditelnými závěsy. Toto pravidlo platí i pro ven otvíravé dveře.

	DIN - LEVÉ OTEVÍRÁNÍ		DIN - PRAVÉ OTEVÍRÁNÍ	
	<p>Vnitřní strana</p> <p>Venkovní strana</p>	<p>Vnitřní strana</p> <p>Venkovní strana</p>	<p>Vnitřní strana</p> <p>Venkovní strana</p>	<p>Vnitřní strana</p> <p>Venkovní strana</p>
Dveře	Levé	Levé	Pravé	Pravé
Závěsy	Levé	Levé	Pravé	Pravé
Zámek	Levý	Levý	Pravý	Pravý
Klika/ klika	Levá	Pravá	Pravá	Levá
Klika/ koule	Levá	Pravá	Pravá	Levá
WC garnitura	Levá	Pravá	Pravá	Levá
Klika se čtyřhranem	Pravá	Levá	Levá	Pravá
Klika bez čtyřhranu	Levá	Pravá	Pravá	Levá

© R.S.P. s.r.o. Týn nad Vltavou

Verze: HOP-SP-06.14

Platnost od: 15.03.2014

Tisk: 01.03.2014

Technické změny vyhrazeny!



ZÁKLADNÍ INFORMACE - MATERIÁL, POVRCH A ÚDRŽBA

Hliník

Nerez

Mosaz

Plast



HLINÍK:

Hliníkové kování značky HOPPE je zhotoveno z vysoce kvalitní, korozi odolné slitiny. Zušlechtní povrchu HOPPE souprav z lehkých kovů se docílí eloxováním nebo nanášením práškové barvy. Eloxování je cíleně řízený proces chemické úpravy, kdy za použití proudu a kyseliny sírové se vyvolá oxidace (sloučeniny hliníku a kyslíku) - tím vznikne na povrchu ochranná vrstva. Ta ochraňuje produkty proti vlivům, jako je např. pot z rukou, vzdušná vlhkost, lehké mechanické namáhání. Poškození povrchu jako je např. poškrábání klíčem nebo prstýnkem nevyvolá materiálovou korozi.

Při práškovém ošetření je na hliníkový povrch elektrostaticky nanášen prášek a následně vypálen při teplotě 150-200 °C. Při používání hliníkového kování není známo ohrožení zdraví. Hliník také nepotřebuje speciální péči, zašpinění se odstraní pomocí vlhkého hadříku.



UŠLECHTILÁ OCEL (NEREZ):

Nerezové kování značky HOPPE je zhotoveno z chromniklové oceli. (Materiál číslo - 1.4301). Technickými parametry - jako je dlouhá životnost, vysoká odolnost vůči vlivům životního prostředí, neohrožení zdraví, stálosti vůči kyselinám, odolnosti proti korozi a oděru, se řadí k předmětům, které se mohou používat nejenom ve stavebnictví, ale i v medicíně a v potravinářském průmyslu.

Ušlechtilá ocel je označována jako „NEREZ“, neboť složky slitiny chromu a niklu tvoří neviditelnou pasivní vrstvu. Pokud se přesto na povrchu vytvoří skvrny rzi, jedná se o tzv. letmou skvrnu, to znamená rez, která se vytvořila působením znečištěného prostředí na kování - takovéto skvrny nebo skvrny od oleje, se dá odstranit běžným čistícím prostředkem.

Kování z ušlechtilé oceli může být též chráněno povrchem **Resista®**.



MOSAZ:

Značkové kování HOPPE z mosazi je zhotoveno z nejlepších slitin. Povrch je chráněn transparentním vypalovacím lakem nebo pochromováním s velmi dobrou odolností proti rozpouštědlům a chemikáliím. Pokud je vypalovací lak porušen mechanicky např. klíčem, potom dochází v místě porušení k oxidaci povrchu - místo zahnědne. Kování z mosazi nepotřebuje zvláštní zacházení. Znečištění se odstraní vodou a jemným hadříkem. Nesmí se používat zdrsňující čistící prostředky. Mosazné kování HOPPE může být opatřeno také vysoce odolným povrchem **Resista®**.



PLAST:

Značkové plastové klíky HOPPE jsou zhotoveny z polyamidu (POM), který vykazuje dobrou rázovou odolnost a odolnost proti opotřebením. Díky dobrému antistatickému chování, odolnost proti vlivům počasí a stálosti vůči chemickým látkám je tento materiál vhodný k výrobě kování. Produkty HOPPE z plastu jsou UV stabilní.

Znečištění se odstraní vodou nebo obvyklými čistícími prostředky.





ZÁKLADNÍ INFORMACE - RESISTA

Hliník

Nerez

Mosaz

Plast

Resista® - 10 let garance na povrchovou úpravu

Vybrané druhy kování s povrchovou ochranou **Resista®** mají speciální ochrannou vrstvu, která je nanášena na základní materiál - ušlechtilou ocel nebo mosaz.

Všechny výrobky s garancí povrchové úpravy **Resista®** podléhají trvalé kontrole kvality a odpovídají nově požadavkům evropské normy EN 1670 („Stavební kování - Odolnost proti korozi - Požadavky a zkušební metody“)

Vlastnosti		Využití		<u>Návod na ošetření:</u> Kování s povrchem Resista® nepotřebují žádnou zvláštní péči. Nečistoty se odstraní vodou a jemným hadříkem. Nepoužívejte silné chemické čisticí prostředky.
	Tvrký a odolný proti opotřebení		Vysoká odolnost proti otěru	
	Vysoká odolnost proti korozi		Povrchová stálost a dlouhotrvající lesk	
	UV stabilita		Konstantní barva povrchu	
	Stálý proti vlivům prostředí		Ochrana povrchu před deštěm, ozonem, solí	



Resista® - Prohlášení o záruce

Prohlášení o záruce:

Nad rámec záruky prodejce za vady poskytujeme za následujících předpokladů a v následně vymezeném rozsahu záruku odolnosti povrchu kování. Jako výrobce garantujeme dokonalou odolnost povrchů kování HOPPE při přiměřeném používání. Záruka se vztahuje na povrch **Resista®** a zahrnuje všechny vady prokazatelně vzniklé při výrobě nebo vadou materiálu, obzvláště když povrch zmatní, popř. se potrhá (tvorba skvrn) nebo se ochranný povrch odlupuje.

Záruka se nevztahuje:

- na všechny vyměnitelné součásti, např. šrouby, čtyřhrany, pera, atd..

Kromě toho se záruka dále nevztahuje na škody vzniklé -

- nevhodným a nepřiměřeným používáním
- nesprávným a nedbalým zacházením
- nedodržením návodu na montáž a údržbu, vlastními zásahy a opravami
- chemickým a fyzikálním působením na povrch, mimo běžné použití, např. poškození ostrými předměty.

Podmínky záruky:

Poskytnutí záruky spočívá výhradně v tom, že v případě, vyskytne-li se během naší záruční lhůty funkční vada na kování HOPPE, provedeme dle našeho uvážení prvním konečnému spotřebiteli bezplatnou opravu výrobku nebo bezplatně dodáme stejné nebo jiné odpovídající kování. Ostatní náklady s tímto vzniklé, jako např. cestovné, poštovné, apod. nebudou hrazeny. Nárok na uplatnění záruky vzniká pouze po předložení výrobku a dokladu, že vada na povrchu vznikla v průběhu záruční lhůty. Tímto dokladem je především účtenka s nákupní cenou, proto doporučujeme uchovat tento doklad nejméně do vypršení záruční lhůty.

Záruční lhůta:

Záruční lhůta činí 10 let a začíná dnem nákupu prvním konečným spotřebitelem. Při reklamaci se obraťte prosím s výrobkem a odpovídající účtenkou přímo na prodejce nebo výrobce.

HOPPE Holding AG
Via Friedrich Hoppe
CH-7537 Müstair





ZÁKLADNÍ INFORMACE - SECUSTIK

Hliník

Nerez

Mosaz

Plast



pocit...



vzhled...



zvuk...



Secustik® - okenní klika se slyšitelným plus pro Vaši bezpečnost

Systém **Secustik®** je chráněn ochrannou známkou a patentem. Okenní kličky **Secustik®** mají patentovaný blokovací mechanismus jako integrovanou záruku bezpečnosti. Tento mechanismus umožňuje normální ovládání okenní kliky zevnitř, ale blokuje kliku v případě, že se někdo pokusí s okenní klikou manipulovat zvenku pomocí kování.

Tím kliky plní požadavky podle AhS RAL-RG607/13. Při otáčení klikou **Secustik®** o 180° z uzavřené polohy do výklopné polohy, blokovací mechanismus postupně zapadá se slyšitelným cvakáním do speciálních drážek - a to je slyšitelné plus pro větší bezpečnost oken.



Patentovaný blokovací mechanismus okenní kliky **Secustik®**.



Při otáčení okenní klikou zapadávají pružně uložené zajišťovací kolíčky ① přesným cvaknutím do speciálních drážek v pouzdře ② - tím vzniká typický zvuk **Secustik®** - slyšitelné plus pro bezpečnost.



Během otáčivého pohybu jsou zajišťovací kolíčky ① pomocí spojovacího prvku ③ unášeny k dalším drážkám ②, do kterých opět slyšitelně zapadnou.

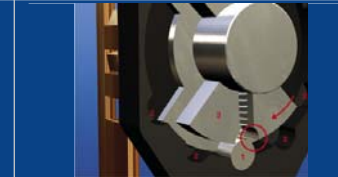

Při pokusu o vloupání jsou zajišťovací kolíčky ① spojovacím prvkem ③ zatlačeny do drážek v pouzdře ②.

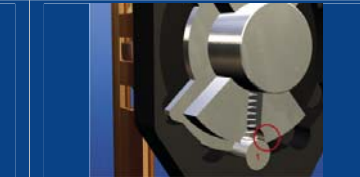

V této poloze kolíčky ① účinně brání v otočení okenní klikou zvenku. Okenní klička se zablokuje a zmaří pokus o vloupání.



ZÁKLADNÍ INFORMACE - BEZPEČNOSTNÍ KOVÁNÍ
Hliník
Nerez
Mosaz
Plast
HOPPE Kování s ocelovou ochranou proti odvrtání

HOPPE - kování s ocelovou ochranou proti odvrtání, nejsou vyložene bezpečnostní kování jako taková, tj. dle DIN 18257, ale takováto kování ztěžují oproti obyčejnému kování navrtání v oblasti zámkové vložky.

Kování s ocelovou ochranou proti odvrtání jsou vyráběna bez zakrytí zámkové vložky (ZA) v provedení - **mosaz**.

HOPPE Bezpečnostní kování dle DIN 18257 ES0 (SK1)

HOPPE - kování v nově zavedené bezpečnostní třídě ES0 (SK1) nabízí oproti obyčejnému kování zvýšenou ochranu - kalené šrouby, překrytí (zneviditelnění) šroubů venkovním štítem.

Tato bezpečnostní kování jsou vyráběna bez zakrytí zámkové vložky (ZA) v provedení - **hliník**.

HOPPE Bezpečnostní kování dle DIN 18257 ES1 (SK2)

HOPPE - kování v bezpečnostní třídě ES1 (SK2) nabízí oproti obyčejnému kování vysokou ochranu proti odvrtání - kalené šrouby, ocelové výztuhy v ploše celého štítku, ocelové noky pro přišroubování šroubů, zalisované ocelové kuličky v nocích. Bezpečnostní kování ES1 (SK2) je kriminální policií doporučeno jako standardní.

Tato bezpečnostní kování jsou vyráběna bez zakrytí a se zakrytím zámkové vložky (ZA) v provedení - **hliník, ušlechtilá ocel, mosaz**.

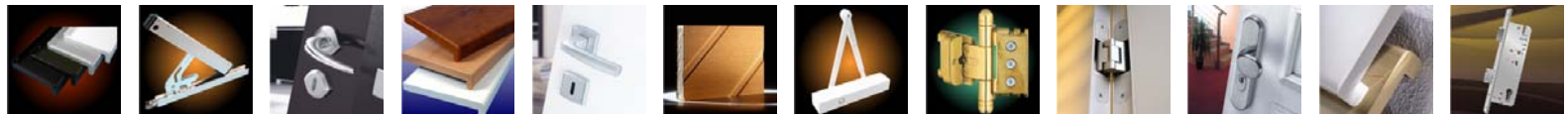
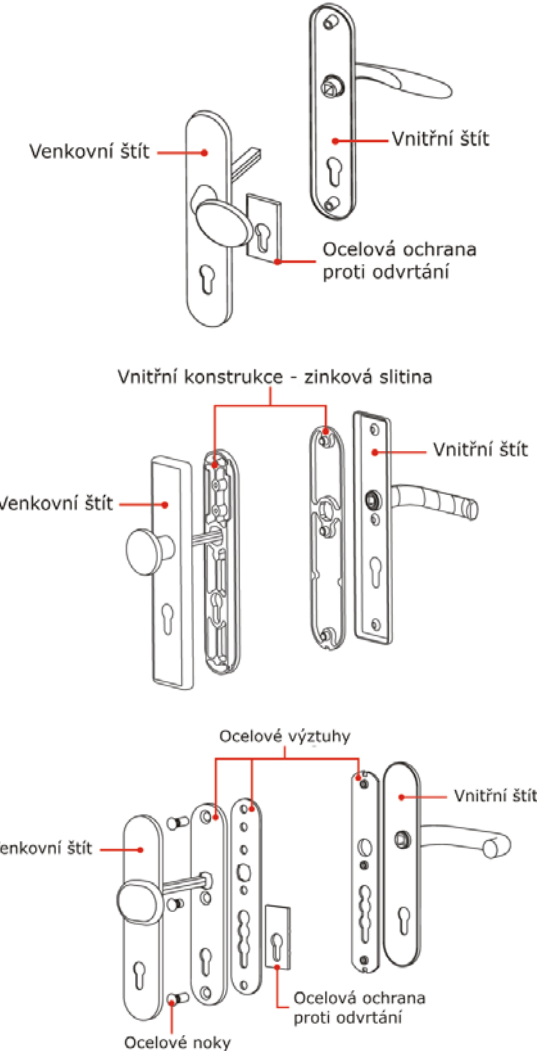

ZÁKLADNÍ INFORMACE - UPEVNĚNÍ MADEL
Hliník
Nerez
Mosaz
Plast

**HOPPE systém upevnění madel
Nr. 1**

- Jednostranné upevnění madel na plastové a hliníkové profily je vybaveno rozpěrným systémem, pomocí kterého je madlo pevně a dlouhodobě usazeno na dveřích bez postupného viklání.



- Rozepřením v ocelové nebo hliníkové výztuze se pomocí rozpěrného kroužku vytvoří trvalé a pevné spojení.

- Jednostranné upevnění madel na dřevěné dveře je navíc kromě rozpěrného upevňovacího systému vybaveno objímkou se závitem. Ta dodává systému ještě větší pevnost.



- Pro montáž madla do plastových profilů s ocelovou nebo hliníkovou výztuhou slouží systém - **Nr.1, Nr.5, Nr.11** - viz strana **79, 80**.
Pro montáž madla do dřevěných profilů slouží systém - **Nr.2, Nr.5, Nr.11** - viz strana **79, 80**.

Výše jmenovaná HOPPE upevnění jsou patentově chráněna.

**HOPPE systém upevnění madel
Nr. 11**
BS-1101

- - řešení při problémové montáži madla v oblasti skříňky zámku
- - použitelný u všech PVC profilů s rozměrem „V“ od 11-16 mm dřevěných a hliníkových profilů kromě jednokomorových profilů

BS-1102 a BS-1103

- - používá se u všech plastových, hliníkových a dřevěných profilů s tloušťkou od 56 mm s výjimkou jednokomorových
- - použitelný bez závislosti na rozměru „V“
- - jednoduchá a časově nenáročná montáž (je nutný pouze vrták Ø 10 mm)
- - upevňovací systém je vybaven samořezným závitem

Důležité:

K pevnému a bezproblémovému upevnění madel na dveře, doporučujeme při montáži používat HOPPE montážní sadu šablon.





R.S.P. s.r.o.

OKENNÍ KLIKY A BALKÓNOVÉ SOUPRAVY

Hliník

Nerez

Mosaz

Plast

AMSTERDAM E0400	17-19	LUXEMBOURG 099	43-45
ATHINAI M056	19	NEW YORK 0810	45-60
ATLANTA 0530/ M0530	20-32	PARIS 037/ E038	61-63
BILBAO E0365	33	SALVADOR 0756	64
BONN E050	34-36	STOCKHOLM E0140	64-65
CARDIFF E0850	36	TOKYO 0710	66-74
DALLAS E0643	37-39	TRONDHEIM E0430	74
DENVER E0310	39-40	VERONA 0510/ E0800/ M051	75-76
GÖTEBORG E0410	40	Nástrčná klika SG0710RH	77
HELSINGBORG E0730	41	Rozety nástrčné kliky U26SV	77
LAS VEGAS E0440	41	Balkónová madélka 430/70 + K435	78
LONDON M013	42-43	Kótované nákresy	79-90



© R.S.P. s.r.o. Týn nad Vltavou

Verze: HOP-SP-06.14

Platnost od: 15.03.2014

Tisk: 01.03.2014

Technické změny vyhrazeny!

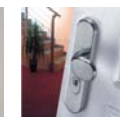
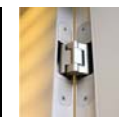
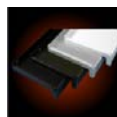





OKENNÍ KLIKY A BALKÓNOVÉ SOUPRAVY
Hliník
Nerez
Mosaz
Plast

Vyobrazení	Obj. číslo	Čtyřhran			TS	Šroub	Kód barvy	Barevné provedení	Sklad	Cena brutto v Kč	
			SST								
	HS-E0400Z/431N/422-UG							AMSTERDAM			
	2619608	10	-	UG	70-75	-	F69/F32-1	Nerez matná/elox nerez	X	5 842,-	
	HS-E0400Z/431N/422-PZ							AMSTERDAM			
	2657874	10	-	PZ/69	70-75	-	F69/F32-1	Nerez matná/elox nerez	X	5 842,-	





OKENNÍ KLIKY A BALKÓNOVÉ SOUPRAVY
Hliník
Nerez
Mosaz
Plast

Vyobrazení	Obj. číslo	Čtyřhran			TS	Šroub	Kód barvy	Barevné provedení	Sklad	Cena brutto v Kč	
			SST								
<i>Kótovaný náčres Str./ poz. 79/ 5</i>	HS-E0400Z/431N-PZ							AMSTERDAM			
	2619616	10	-	PZ/69	55-75	-	F69	Nerez matná	X	11 221,-	
<i>Kótovaný náčres Str./ poz. 79/ 6</i>	M056/US937							ATHINAI			
	3590501	7/32	-	-	-	-	F49-R/F98-R	Chrom/ matný-Resista®	X	1 529,-	
	3590536	7/32	-	-	-	-	F72/F9	Mosaz/ elox ocel	X	1 529,-	
	3590528	7/32	-	-	-	-	F98/H07	Chrom matný/ buk	X	1 529,-	

















OKENNÍ KLIKY A BALKÓNOVÉ SOUPRAVY
Hliník
Nerez
Mosaz
Plast

Vyobrazení	Obj. číslo	Čtyřhran			TS	Šroub	Kód barvy	Barevné provedení	Sklad	Cena brutto v Kč	
			SST								
<i>Kótovaný náčres Str./ poz. 80/ 1</i>	0530/US952							ATLANTA			
	2210335	7/35	-	-	-	-	F1	Elox přírodní		84,-	
	2243428	7/35	-	-	-	-	F4	Elox bronz		93,-	
	2210343	7/35	-	-	-	-	F9	Elox ocel		89,-	
	2254637	7/35	-	-	-	-	F8707	Tmavohnědá lesklá		84,-	
	2236957	7/35	-	-	-	-	F9016	Bílá	✓	80,-	
<i>Kótovaný náčres Str./ poz. 80/ 1</i>	0530/US952/45°							ATLANTA			
	2245731	7/35	-	-	-	M5x45	F1	Elox přírodní	✓	82,-	
	2684670	7/35	-	-	-	M5x45	F2	Elox alpaka	✗	334,-	
	2245749	7/35	-	-	-	M5x45	F4	Elox bronz	✓	93,-	
	2245757	7/35	-	-	-	M5x45	F9	Elox ocel	✓	91,-	
	2291147	7/35	-	-	-	M5x45	F8707	Tmavohnědá lesklá	✓	82,-	
	2245765	7/35	-	-	-	M5x45	F9016	Bílá	✓	80,-	





OKENNÍ KLIKY A BALKÓNOVÉ SOUPRAVY
Hliník
Nerez
Mosaz
Plast

Vyobrazení	Obj. číslo	Čtyřhran			TS	Šroub	Kód barvy	Barevné provedení	Sklad	Cena brutto v Kč	
			SST								
Kótovaný náčres Str./ poz. 80/ 1	0530/US952/45°							ATLANTA			
	2427121	7/40	-	-	-	M5x50	F1	Elox přírodní		82,-	
	2622591	7/40	-	-	-	-	F2	Elox alpaka		326,-	
	2324922	7/40	-	-	-	M5x50	F4	Elox bronz		93,-	
	2266831	7/40	-	-	-	M5x50	F9	Elox ocel		91,-	
	2443500	7/40	-	-	-	M5x50	F8707	Tmavohnědá lesklá		82,-	
	3271826	7/40	-	-	-	M5x50	F9016	Bílá		80,-	
Kótovaný náčres Str./ poz. 80/ 1	0530/US952/45°							ATLANTA			
	2357433	7/45	-	-	-	M5x55	F1	Elox přírodní		82,-	
	2333141	7/45	-	-	-	M5x55	F4	Elox bronz		93,-	
	2357468	7/45	-	-	-	M5x55	F9	Elox ocel		91,-	
	2333159	7/45	-	-	-	M5x55	F9016	Bílá		80,-	









OKENNÍ KLIKY A BALKÓNOVÉ SOUPRAVY
Hliník
Nerez
Mosaz
Plast

Vyobrazení	Obj. číslo	Čtyřhran			TS	Šroub	Kód barvy	Barevné provedení	Sklad	Cena brutto v Kč	
			SST								
Kótovaný náčrtek Str./ poz. 80/ 2	0530S/US952							ATLANTA			
	2257969	7/35	-	-	-	-	F1	Elox přírodní	X	935,-	
	2306564	7/35	-	-	-	-	F4	Elox bronz	X	1 054,-	
	2257977	7/35	-	-	-	-	F9	Elox ocel	X	1 054,-	
	2257993	7/35	-	-	-	-	F8707	Tmavohnědá lesklá	X	936,-	
	2257985	7/35	-	-	-	-	F9016	Bílá	✓	674,-	
Kótovaný náčrtek Str./ poz. 80/ 2	0530S/US952							ATLANTA			
	2258005	7/40	-	-	-	-	F1	Elox přírodní	X	941,-	
	2362523	7/40	-	-	-	-	F4	Elox bronz	X	1 060,-	
	2258013	7/40	-	-	-	-	F9	Elox ocel	X	1 060,-	
	2258030	7/40	-	-	-	-	F8707	Tmavohnědá lesklá	X	941,-	
	2258021	7/40	-	-	-	-	F9016	Bílá	☎	674,-	



OKENNÍ KLIKY A BALKÓNOVÉ SOUPRAVY

Hliník
Nerez
Mosaz
Plast

Vyobrazení	Obj. číslo	Čtyřhran			TS	Šroub	Kód barvy	Barevné provedení	Sklad	Cena brutto v Kč	
			SST								
Kótovaný náčrtek Str./ poz. 80/ 2	0530S/US952/45°							ATLANTA			
	2575191	7/35	-	-	-	-	F1	Elox přírodní	✓	700,-	
	3581277	7/37	-	-	-	-	F2	Elox alpaka	✗	961,-	
	2394867	7/35	-	-	-	M5x45	F4	Elox bronz	✓	803,-	
	2394875	7/35	-	-	-	M5x45	F9	Elox ocel	✓	803,-	
	2575220	7/35	-	-	-	-	F8707	Tmavohnědá lesklá	✗	955,-	
	2394883	7/35	-	-	-	M5x45	F9016	Bílá	✓	674,-	
Kótovaný náčrtek Str./ poz. 80/ 2	0530S/US952/45°							ATLANTA			
	2536394	7/40	-	-	-	M5x50	F1	Elox přírodní		816,-	
	2536415	7/40	-	-	-	M5x50	F4	Elox bronz		934,-	
	2339139	7/40	-	-	-	M5x50	F9	Elox ocel		915,-	
	2536474	7/40	-	-	-	M5x50	F9016	Bílá	✓	674,-	







OKENNÍ KLIKY A BALKÓNOVÉ SOUPRAVY
Hliník
Nerez
Mosaz
Plast

Vyobrazení	Obj. číslo	Čtyřhran			TS	Šroub	Kód barvy	Barevné provedení	Sklad	Cena brutto v Kč	
			SST								
	0530SV/U26							ATLANTA			
	2258101	7/35	-	-	-	-	F1	Elox přírodní	X	584,-	
	2308252	7/35	-	-	-	M5x45	F4	Elox bronz	X	663,-	
	2258110	7/35	-	-	-	-	F9	Elox ocel	X	650,-	
	2258136	7/35	-	-	-	-	F8707	Tmavohnědá lesklá	X	585,-	
	2258128	7/35	-	-	-	-	F9016	Bílá	X	584,-	
	0530SV/U26							ATLANTA			
	2258144	7/40	-	-	-	-	F1	Elox přírodní	X	590,-	
	2362443	7/40	-	-	-	-	F4	Elox bronz	X	685,-	
	2258152	7/40	-	-	-	-	F9	Elox ocel	X	656,-	
	2258179	7/40	-	-	-	-	F8707	Tmavohnědá lesklá	X	599,-	
	2258161	7/40	-	-	-	-	F9016	Bílá	X	590,-	



OKENNÍ KLIKY A BALKÓNOVÉ SOUPRAVY
Hliník
Nerez
Mosaz
Plast

Vyobrazení	Obj. číslo	Čtyřhran			TS	Šroub	Kód barvy	Barevné provedení	Sklad	Cena brutto v Kč	
			SST								
Kótovaný náčres Str./ poz. 80/ 3	0530SV/U26/45°							ATLANTA			
	2422101	7/35	-	-	-	M5x45	F1	Elox přírodní	X	612,-	
	2422080	7/35	-	-	-	M5x45	F4	Elox bronz	X	679,-	
	2776339	7/35	-	-	-	M5x45	F9	Elox ocel	X	679,-	
	2653881	7/35	-	-	-	M5x45	F9016	Bílá	X	467,-	
Kótovaný náčres Str./ poz. 80/ 3	0530SV/U26/45°							ATLANTA			
	2537012	7/40	-	-	-	-	F1	Elox přírodní	X	618,-	
	2537021	7/40	-	-	-	M5x50	F4	Elox bronz	X	687,-	
	2537039	7/40	-	-	-	M5x50	F9	Elox ocel	X	639,-	
	2537047	7/40	-	-	-	M5x50	F9016	Bílá	X	618,-	

















OKENNÍ KLIKY A BALKÓNOVÉ SOUPRAVY
Hliník
Nerez
Mosaz
Plast

Vyobrazení	Obj. číslo	Čtyřhran		TS	Šroub	Kód barvy	Barevné provedení	Sklad	Cena brutto v Kč	
			SST							
	0530/66N/U26/0530/66NS/49PNS						ATLANTA			
	2331487	7	-	PZ	72-77	-	F1	Elox přírodní	✓	982,-
	2916135	7	-	PZ	72-77	-	F4	Elox bronz	✓	1 111,-
	3028931	7	-	PZ	72-77	-	F4/F9016	Elox bronz/ bílá	✓	1 262,-
	2837031	7	-	PZ	72-77	-	F9	Elox ocel	✓	1 111,-
	2916143	7	-	PZ	72-77	-	F8707	Tmavohnědá lesklá	✓	1 111,-
	2837082	7	-	PZ	72-77	-	F9016	Bílá	✓	1 111,-
	0530/66N/U26/0530/66NS/49PNS						ATLANTA			
	2355681	7	-	PZ	78-83	-	F1	Elox přírodní		1 085,-
	2308586	7	-	PZ	78-83	-	F2	Elox alpaka		1 256,-
	2308594	7	-	PZ	78-83	-	F4	Elox bronz		1 230,-
	2309474	7	-	PZ	78-83	-	F9	Elox ocel		1 230,-
	2309466	7	-	PZ	78-83	-	F8707	Tmavohnědá lesklá		1 230,-
	2308578	7	-	PZ	78-83	-	F9016	Bílá		1 230,-



OKENNÍ KLIKY A BALKÓNOVÉ SOUPRAVY
Hliník
Nerez
Mosaz
Plast

Vyobrazení	Obj. číslo	Čtyřhran			TS	Šroub	Kód barvy	Barevné provedení	Sklad	Cena brutto v Kč	
			SST								
<i>Kótovaný náčrtek Str./ poz. 80/ 5</i>	0990KH/66N/U26/0530/66NS/49PNS							ATLANTA			
	2398091	7	-	PZ	78-83	-	F1	Elox přírodní		1 085,-	
	2309079	7	-	PZ	78-83	-	F4	Elox bronz		1 230,-	
	2309491	7	-	PZ	78-83	-	F9	Elox ocel		1 230,-	
	2309482	7	-	PZ	78-83	-	F8707	Tmavohnědá lesklá		1 423,-	
	2309052	7	-	PZ	78-83	-	F9016	Bílá		1 230,-	
<i>Kótovaný náčrtek Str./ poz. 80/ 6</i>	PSK-0530/US952-1							ATLANTA			
	3211161	7/40	-	-	-	M5x45	F1	Elox přírodní		944,-	
	3211225	7/40	-	-	-	M5x45	F4	Elox bronz		1 062,-	
	3211196	7/40	-	-	-	M5x45	F9	Elox ocel		1 062,-	
	3211292	7/40	-	-	-	M5x45	F8707	Tmavohnědá lesklá		944,-	
	3211250	7/40	-	-	-	M5x45	F9016	Bílá		944,-	







OKENNÍ KLIKY A BALKÓNOVÉ SOUPRAVY
Hliník
Nerez
Mosaz
Plast

Vyobrazení	Obj. číslo	Čtýřhran			TS	Šroub	Kód barvy	Barevné provedení	Sklad	Cena brutto v Kč	
			SST								
 <i>Kótovaný náčres Str./ poz. 81/ 1</i>	HS-0530/431N/422-UG							ATLANTA			
	3322081	10	-	UG	70-75	-	F1	Elox přírodní	X	1 764,-	
	3322099	10	-	UG	70-75	-	F9	Elox ocel	X	2 029,-	
	3322101	10	-	UG	70-75	-	F9016	Bílá	X	1 764,-	
 <i>Kótovaný náčres Str./ poz. 81/ 2</i>	HS-0530/431N-PZ							ATLANTA			
	3322515	10	-	PZ/69	65-75	-	F1	Elox přírodní	X	3 034,-	
	3322558	10	-	PZ/69	65-75	-	F9	Elox ocel	X	3 489,-	
	3322486	10	-	PZ/69	65-75	-	F9016	Bílá	X	3 034,-	



OKENNÍ KLIKY A BALKÓNOVÉ SOUPRAVY
Hliník
Nerez
Mosaz
Plast

Vyobrazení	Obj. číslo	Čtyřhran			TS	Šroub	Kód barvy	Barevné provedení	Sklad	Cena brutto v Kč	
			SST								
Kótovaný náčres Str./ poz. 81/ 3	M0530/US956							ATLANTA			
 <p>Secustik®</p> <p>Resista® 10-letá záruka na povrchovou úpravu</p>	2465776	7/35	-	-	-	M5x45	F41-R	Chrom satin-Resista®	X	762,-	
	2294655	7/35	-	-	-	-	F49-R	Chrom-Resista®	X	747,-	
	2236412	7/35	-	-	-	-	F71	Mosaz lesklá	X	577,-	
	2303380	7/35	-	-	-	M5x50	F71	Mosaz lesklá	X	621,-	
	2244199	7/35	-	-	-	-	F73	Mosaz brynýrovaná	X	577,-	
	2431630	7/35	-	-	-	M5x50	F73	Mosaz brynýrovaná	X	621,-	
	2144876	7/35	-	-	-	-	F77-R	Mosaz lesklá-Resista®	X	833,-	
Kótovaný náčres Str./ poz. 81/ 3	M0530/US956							ATLANTA			
 <p>Secustik®</p> <p>Resista® 10-letá záruka na povrchovou úpravu</p>	2722541	7/40	-	-	-	M5x50	F41-R	Chrom satin-Resista®	X	650,-	
	2236383	7/40	-	-	-	M5x50	F71	Mosaz lesklá	X	630,-	







OKENNÍ KLIKY A BALKÓNOVÉ SOUPRAVY
Hliník
Nerez
Mosaz
Plast

Vyobrazení	Obj. číslo	Čtyřhran			TS	Šroub	Kód barvy	Barevné provedení	Sklad	Cena brutto v Kč
			SST							
<p>Secustik®</p> <p>Resista® 10-letá záruka na povrchovou úpravu</p>	M0530/US956							ATLANTA		
	2244261	7/45	-	-	-	-	F41-R	Chrom satin- Resista®	X	754,-
	2244228	7/45	-	-	-	-	F71	Mosaz lesklá	X	614,-
	2244244	7/45	-	-	-	-	F73	Mosaz brynýrovaná	X	614,-
	2244308	7/45	-	-	-	-	F77-R	Mosaz lesklá- Resista®	X	833,-
<p>Secustik®</p> <p>45°</p> <p>Resista® 10-letá záruka na povrchovou úpravu</p>	M0530/US956/45°							ATLANTA		
	2472394	7/35	-	-	-	-	F41-R	Chrom satin- Resista®	X	718,-
	2339121	7/35	-	-	-	-	F71	Mosaz lesklá		504,-
	3223980	7/35	-	-	-	M5x45	F73	Mosaz brynýrovaná	X	597,-
	2472571	7/35	-	-	-	-	F77-R	Mosaz lesklá- Resista®	X	800,-



OKENNÍ KLIKY A BALKÓNOVÉ SOUPRAVY
Hliník
Nerez
Mosaz
Plast

Vyobrazení	Obj. číslo	Čtyřhran			TS	Šroub	Kód barvy	Barevné provedení	Sklad	Cena brutto v Kč	
			SST								
Kótovaný nákres Str./ poz. 81/ 3	M0530/US956/45°							ATLANTA			
 <p>Secustik® 45°</p> <p>Resista® 10-letá záruka na povrchovou úpravu</p>	2472714	7/45	-	-	-	-	F41-R	Chrom satin-Resista®	X	762,-	
	2472749	7/45	-	-	-	-	F71	Mosaz lesklá	X	622,-	
	2472757	7/45	-	-	-	-	F77-R	Mosaz lesklá-Resista®	X	848,-	
Kótovaný nákres Str./ poz. 81/ 4	M0530/U61/U23/0530/66NS/49PNS							ATLANTA			
 <p>Resista® 10-letá záruka na povrchovou úpravu</p>	2520149	7	-	PZ	54-63	-	F77-R	Mosaz lesklá-Resista®	X	3 635,-	
	3147008	7	-	PZ	89-93	-	F41-R	Chrom satin-Resista®	X	2 511,-	
	3146996	7	-	PZ	89-93	-	F71	Mosaz lesklá	X	2 306,-	







OKENNÍ KLIKY A BALKÓNOVÉ SOUPRAVY
Hliník
Nerez
Mosaz
Plast

Vyobrazení	Obj. číslo	Čtyřhran		TS	Šroub	Kód barvy	Barevné provedení	Sklad	Cena brutto v Kč	
			SST							
<i>Kótovaný nákres Str./ poz. 81/ 5</i>	HS-M0530/431N/423-UG						ATLANTA			
	2730787	10	-	UG	70-75	-	F41-R	Chrom satin-Resista®	X	5 000,-
	2730795	10	-	UG	70-75	-	F49-R	Chrom-Resista®	X	5 000,-
	2730752	10	-	UG	70-75	-	F71	Mosaz lesklá	X	4 055,-
	2730808	10	-	UG	70-75	-	F77-R	Mosaz lesklá-Resista®	X	5 576,-
<i>Kótovaný nákres Str./ poz. 81/ 6</i>	HS-M0530/431N-PZ						ATLANTA			
	2730841	10	-	PZ/69	65-75	-	F41-R	Chrom satin-Resista®	X	9 479,-
	2730859	10	-	PZ/69	65-75	-	F49-R	Chrom lesk-Resista®	X	9 479,-
	2730816	10	-	PZ/69	65-75	-	F71	Mosaz lesklá	X	7 689,-
	2730867	10	-	PZ/69	65-75	-	F77-R	Mosaz lesklá-Resista®	X	10 572,-









OKENNÍ KLIKY A BALKÓNOVÉ SOUPRAVY Hliník Nerez Mosaz Plast

Vyobrazení	Obj. číslo	Čtyřhran			TS	Šroub	Kód barvy	Barevné provedení	Sklad	Cena brutto v Kč
			SST							
<i>Kótovaný náčres Str./ poz. 82/ 1</i>	E0365/US956	BILBAO								
	2044251	7/35	-	-	-	-	F69	Nerez matná	X	1 002,-
<i>Kótovaný náčres Str./ poz. 82/ 1</i>	E0365/US956	BILBAO								
	2324279	7/40	-	-	-	-	F69	Nerez matná	X	1 008,-







OKENNÍ KLIKY A BALKÓNOVÉ SOUPRAVY
Hliník
Nerez
Mosaz
Plast

Vyobrazení	Obj. číslo	Čtyřhran			TS	Šroub	Kód barvy	Barevné provedení	Sklad	Cena brutto v Kč	
			SST								
 	E050/US956							BONN			
	1908512	7/35	-	-	-	-	F69	Nerez matná	X	1 754,-	
 	E050/US956							BONN			
	3186576	7/40	-	-	-	-	F69	Nerez matná	X	1 759,-	





OKENNÍ KLIKY A BALKÓNOVÉ SOUPRAVY
Hliník
Nerez
Mosaz
Plast

Vyobrazení	Obj. číslo	Čtyřhran			TS	Šroub	Kód barvy	Barevné provedení	Sklad	Cena brutto v Kč	
			SST								
<i>Kótovaný náčres Str./ poz. 82/ 2</i>	E050/US956/45°							BONN			
	3353266	7/35	-	-	-	-	F69	Nerez matná	X	1 759,-	
<i>Kótovaný náčres Str./ poz. 82/ 3</i>	HS-E050Z/431N/422-UG							BONN			
	2619641	10	-	UG	70-75	-	F69/F32-1	Nerez matná	X	5 080,-	





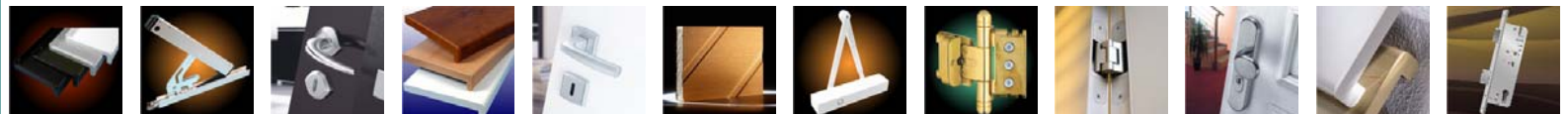

OKENNÍ KLIKY A BALKÓNOVÉ SOUPRAVY
Hliník
Nerez
Mosaz
Plast

Vyobrazení	Obj. číslo	Čtyřhran			TS	Šroub	Kód barvy	Barevné provedení	Sklad	Cena brutto v Kč	
			SST								
<i>Kótovaný náčrtes Str./ poz. 82/ 4</i>	HS-E050Z/431N-PZ							BONN			
	2619659	10	-	PZ/69	55-75	-	F69	Nerez matná	X	9 696,-	
<i>Kótovaný náčrtes Str./ poz. 82/ 5</i>	E0850/U23							CARDIFF			
	3590691	7/35	-	-	-	-	F69	Nerez matná	X	430,-	





OKENNÍ KLIKY A BALKÓNOVÉ SOUPRAVY
Hliník
Nerez
Mosaz
Plast

Vyobrazení	Obj. číslo	Čtyřhran			TS	Šroub	Kód barvy	Barevné provedení	Sklad	Cena brutto v Kč	
			SST								
<i>Kótovaný náčrsek Str./ poz. 82/ 6</i>	E0643/US944							DALLAS			
	3638309	7/37	-	-	-	-	F69	Nerez matná	X	894,-	
<i>Kótovaný náčrsek Str./ poz. 83/ 1</i>	PSK-0643/US944/45°							DALLAS			
	3699611	7/35	-	-	-	-	F1	Elox přírodní	X	917,-	
	3699638	7/35	-	-	-	-	F9	Elox ocel	X	1 031,-	



OKENNÍ KLIKY A BALKÓNOVÉ SOUPRAVY
Hliník
Nerez
Mosaz
Plast

Vyobrazení	Obj. číslo	Čtýřhran			TS	Šroub	Kód barvy	Barevné provedení	Sklad	Cena brutto v Kč	
			SST								
Kótovaný náčres Str./ poz. 83/ 1	PSK-0643/US944/45°							DALLAS			
	3699620	7/45	-	-	-	-	F1	Elox přírodní	X	922,-	
	3699646	7/45	-	-	-	-	F9	Elox ocel	X	1 037,-	
Kótovaný náčres Str./ poz. 83/ 2	HS-0643/419/420-UG							DALLAS			
	3690810	10	-	UG	68-73	-	F1	Elox přírodní	X	1 889,-	
	3690887	10	-	UG	68-73	-	F9	Elox ocel	X	2 172,-	







OKENNÍ KLIKY A BALKÓNOVÉ SOUPRAVY



Vyobrazení	Obj. číslo	Čtyřhran		TS	Šroub	Kód barvy	Hliník			Nerez			Mosaz			Plast		
			SST					Barevné provedení	Sklad	Cena brutto v Kč								
Kótovaný náčrtes Str./ poz. 83/ 3	HS-0643/419-PZ						DALLAS											
	3690916	10	-	PZ/69	65-75	-	F1	Elox přírodní	X				2 860,-					
	3690932	10	-	PZ/69	65-75	-	F9	Elox ocel	X				3 289,-					
Kótovaný náčrtes Str./ poz. 83/ 4	E0310/US956						DENVER											
 Secustik® Rost frei	2798061	7/35	-	-	-	-	F69	Nerez matná	X				642,-					



OKENNÍ KLIKY A BALKÓNOVÉ SOUPRAVY
Hliník
Nerez
Mosaz
Plast

Vyobrazení	Obj. číslo	Čtýřhran			TS	Šroub	Kód barvy	Barevné provedení	Sklad	Cena brutto v Kč	
			SST								
	E0310/US956							DENVER			
	3003215	7/40	-	-	-	-	F69	Nerez matná	X	648,-	
	E0410/US956							GÖTEBORG			
	2436422	7/35	-	-	-	-	F69	Nerez matná	X	1 002,-	





OKENNÍ KLIKY A BALKÓNOVÉ SOUPRAVY							Hliník	Nerez	Mosaz	Plast
Vyobrazení	Obj. číslo	Čtyřhran		TS	Šroub	Kód barvy	Barevné provedení	Sklad	Cena brutto v Kč	
			SST							
Kótovaný náčres Str./ poz. 83/ 6	E0730/U23	HELSINGBORG								
	3590270	7/35	-	-	-	F69	Nerez matná	X	430,-	
Kótovaný náčres Str./ poz. 84/ 1	E0440/US956	LAS VEGAS								
	2072850	7/35	-	-	-	F69	Nerez matná	X	1 621,-	





R.S.P. s.r.o.

OKENNÍ KLIKY A BALKÓNOVÉ SOUPRAVY

							Hliník	Nerez	Mosaz	Plast
Vyobrazení	Obj. číslo	Čtýřhran		TS	Šroub	Kód barvy	Barevné provedení	Sklad	Cena brutto v Kč	
			SST							
 <p>Kótovaný nákrés Str./ poz. 84/ 2</p>	M013/U11Z						LONDON			
	661725	7/32	-	-	-	-	F71	Mosaz lesklá	X	1 092,-
 <p>Kótovaný nákrés Str./ poz. 84/ 2</p>	M013/U11Z/45°						LONDON			
	661688	7/32	-	-	-	-	F71	Mosaz lesklá	X	1 101,-







OKENNÍ KLIKY A BALKÓNOVÉ SOUPRAVY

Hliník

Nerez

Mosaz

Plast

Vyobrazení	Obj. číslo	Čtyřhran			TS	Šroub	Kód barvy	Barevné provedení	Sklad	Cena brutto v Kč	
			SST								
Kótovaný náčrtek Str./ poz. 84/ 3	M013S/U11Z							LONDON			
	816156	7/32	-	-	-	-	F71	Mosaz lesklá	X	2 691,-	
Kótovaný náčrtek Str./ poz. 84/ 4	099/US952							LUXEMBOURG			
	8106056	7/35	-	-	-	-	F1	Elox přírodní	X	355,-	
Secustik®	8106064	7/35	-	-	-	-	F2	Elox alpaka		211,-	
	8106072	7/35	-	-	-	-	F4	Elox bronz	X	387,-	
	8106080	7/35	-	-	-	-	F9	Elox ocel	X	387,-	
	8107252	7/35	-	-	-	-	F8707	Tmavohnědá lesklá	X	356,-	
	8106577	7/35	-	-	-	-	F9016	Bílá	X	355,-	



OKENNÍ KLIKY A BALKÓNOVÉ SOUPRAVY

Hliník

Nerez





Mosaz

Plast

Vyobrazení	Obj. číslo	Čtyřhran			TS	Šroub	Kód barvy	Barevné provedení	Sklad	Cena brutto v Kč	
			SST								
Kótovaný náčrtek Str./ poz. 84/ 4	099/US952/45°							LUXEMBOURG			
	8196552	7/35	-	-	-	-	F1	Elox přírodní		217,-	
	1792994	7/35	-	-	-	-	F2	Elox alpaka		217,-	
	8135956	7/35	-	-	-	-	F4	Elox bronz		248,-	
	1769680	7/35	-	-	-	-	F9	Elox ocel		393,-	
	1763755	7/35	-	-	-	-	F8707	Tmavohnědá lesklá		362,-	
	8135949	7/35	-	-	-	-	F9016	Bílá		187,-	
Kótovaný náčrtek Str./ poz. 84/ 4	099/US952/45°							LUXEMBOURG			
	1884135	7/40	-	-	-	M5x50	F1	Elox přírodní		279,-	
	1862243	7/40	-	-	-	M5x50	F4	Elox bronz		412,-	
	1862251	7/40	-	-	-	M5x50	F9	Elox ocel		412,-	
	2353256	7/40	-	-	-	-	F9016	Bílá		367,-	





OKENNÍ KLIKY A BALKÓNOVÉ SOUPRAVY
Hliník
Nerez
Mosaz
Plast

Vyobrazení	Obj. číslo	Čtyřhran			TS	Šroub	Kód barvy	Barevné provedení	Sklad	Cena brutto v Kč
			SST							
<i>Kótovaný náčrtek Str./ poz. 84/ 5</i>	099KH/U26	LUXEMBOURG								
	1922040	7/35	-	-	-	-	F1	Elox přírodní	X	403,-
	1789306	7/32	-	-	-	-	F4	Elox bronz	X	441,-
	1922058	7/35	-	-	-	-	F9	Elox ocel	X	441,-
	1922082	7/35	-	-	-	-	F8707	Tmavohnědá lesklá	X	403,-
	1922066	7/35	-	-	-	-	F9016	Bílá	✓	258,-
<i>Kótovaný náčrtek Str./ poz. 84/ 6</i>	0810/U76	NEW YORK								
	3371405	7/35	-	-	-	-	F1	Elox přírodní	X	325,-
	3371421	7/35	-	-	-	-	F9	Elox ocel	X	343,-
	3371561	7/35	-	-	-	-	F8707	Tmavohnědá lesklá	X	316,-
	3371587	7/35	-	-	-	-	F9016	Bílá	X	316,-







OKENNÍ KLIKY A BALKÓNOVÉ SOUPRAVY
Hliník
Nerez
Mosaz
Plast

Vyobrazení	Obj. číslo	Čtyřhran			TS	Šroub	Kód barvy	Barevné provedení	Sklad	Cena brutto v Kč	
			SST								
	0810/U10							NEW YORK			
	3407922	7/35	-	-	-	M5x45	F1	Elox přírodní	✓	68,-	
	3383941	7/35	-	-	-	-	F2	Elox alpaka	✓	71,-	
	3459765	7/35	-	-	-	M5x45	F4	Elox bronz	✓	82,-	
	3408247	7/35	-	-	-	M5x45	F9	Elox ocel	✓	82,-	
	3459773	7/35	-	-	-	M5x45	F8707	Tmavohnědá lesklá	✓	68,-	
	3409629	7/35	-	-	-	M5x45	F9016	Bílá	✓	68,-	
	0810/U10/45°							NEW YORK			
	3470438	7/35	-	-	-	M5x45	F1	Elox přírodní	✓	71,-	
	3671475	7/35	-	-	-	-	F2	Elox alpaka	☎	71,-	
	3470446	7/35	-	-	-	M5x45	F4	Elox bronz	✓	82,-	
	3470454	7/35	-	-	-	M5x45	F9	Elox ocel	✓	82,-	
	3470462	7/35	-	-	-	M5x45	F8707	Tmavohnědá lesklá	✓	68,-	
	3470471	7/35	-	-	-	M5x45	F9016	Bílá	✓	68,-	



OKENNÍ KLIKY A BALKÓNOVÉ SOUPRAVY
Hliník
Nerez
Mosaz
Plast

Vyobrazení	Obj. číslo	Čtyřhran			TS	Šroub	Kód barvy	Barevné provedení	Sklad	Cena brutto v Kč	
			SST								
Kótovaný náčres Str./ poz. 85/ 1	0810/U10/45°							NEW YORK			
	3470551	7/40	-	-	-	M5x50	F1	Elox přírodní	✓	71,-	
	3470569	7/40	-	-	-	M5x50	F4	Elox bronz	✓	82,-	
	3470577	7/40	-	-	-	M5x50	F9	Elox ocel	✓	82,-	
	3470585	7/40	-	-	-	M5x50	F8707	Tmavohnědá lesklá	✓	68,-	
	3470593	7/40	-	-	-	M5x50	F9016	Bílá	✓	68,-	
Kótovaný náčres Str./ poz. 85/ 2	0810/US10							NEW YORK			
	3407674	7/35	-	-	-	M5x45	F9016	Bílá		75,-	







OKENNÍ KLIKY A BALKÓNOVÉ SOUPRAVY
Hliník
Nerez
Mosaz
Plast

Vyobrazení	Obj. číslo	Čtyřhran			TS	Šroub	Kód barvy	Barevné provedení	Sklad	Cena brutto v Kč
			SST							
<i>Kótovaný náčrsek Str./ poz. 85/ 2</i>	0810/US10	NEW YORK								
	3407703	7/40	-	-	-	M5x50	F9016	Bílá		75,-
<i>Kótovaný náčrsek Str./ poz. 85/ 2</i>	0810/US10/45°	NEW YORK								
	3470622	7/35	-	-	-	M5x45	F1	Elox přírodní	✓	78,-
	3470631	7/35	-	-	-	M5x45	F4	Elox bronz	✓	91,-
	3470649	7/35	-	-	-	M5x45	F9	Elox ocel	✓	91,-
	3470657	7/35	-	-	-	M5x45	F8707	Tmavohnědá lesklá	✓	75,-
	3470665	7/35	-	-	-	M5x45	F9016	Bílá	✓	75,-



OKENNÍ KLIKY A BALKÓNOVÉ SOUPRAVY
Hliník
Nerez
Mosaz
Plast

Vyobrazení	Obj. číslo	Čtyřhran			TS	Šroub	Kód barvy	Barevné provedení	Sklad	Cena brutto v Kč	
			SST								
<i>Kótovaný náčres Str./ poz. 85/ 2</i>	0810/US10/45°							NEW YORK			
	3470673	7/40	-	-	-	M5x50	F1	Elox přírodní	✓	78,-	
	3470681	7/40	-	-	-	M5x50	F4	Elox bronz	✓	91,-	
	3470690	7/40	-	-	-	M5x50	F9	Elox ocel	✓	91,-	
	3470702	7/40	-	-	-	M5x50	F8707	Tmavohnědá lesklá	✓	75,-	
	3470711	7/40	-	-	-	M5x50	F9016	Bílá	✓	75,-	
<i>Kótovaný náčres Str./ poz. 85/ 2</i>	0810/US10/45°							NEW YORK			
	3480564	7/43	-	-	-	M5x55	F1	Elox přírodní	✓	78,-	
	3542067	7/43	-	-	-	M5x55	F4	Elox bronz	✓	91,-	
	3480581	7/43	-	-	-	M5x55	F9	Elox ocel	✓	91,-	
	3480601	7/43	-	-	-	M5x55	F9016	Bílá	✓	75,-	



OKENNÍ KLIKY A BALKÓNOVÉ SOUPRAVY

Hliník

Nerez













Mosaz

Plast

Vyobrazení	Obj. číslo	Čtyřhran			TS	Šroub	Kód barvy	Barevné provedení	Sklad	Cena brutto v Kč	
			SST								
Kótovaný náčres Str./ poz. 85/ 2	0810/US10/45°							NEW YORK			
	3659556	7/55	-	-	-	M5x55	F1	Elox přírodní	✓	82,-	
	3659564	7/55	-	-	-	M5x55	F4	Elox bronz	✓	94,-	
	3659572	7/55	-	-	-	M5x55	F9	Elox ocel	✓	94,-	
	3659644	7/55	-	-	-	M5x55	F9016	Bílá	✓	79,-	
Kótovaný náčres Str./ poz. 85/ 2	0810/US10/45°							NEW YORK			
	3754924	7/32-42	-	-	-	M5x55	F1	Elox přírodní		85,-	
	3755097	7/32-42	-	-	-	M5x55	F2	Elox alpaka		79,-	
	3755231	7/32-42	-	-	-	M5x55	F4	Elox bronz		97,-	
	3755804	7/32-42	-	-	-	M5x55	F9	Elox ocel		97,-	
	3755839	7/32-42	-	-	-	M5x55	F8707	Tmavohnědá lesklá		82,-	
	3755935	7/32-42	-	-	-	M5x55	F9016	Bílá		82,-	



OKENNÍ KLIKY A BALKÓNOVÉ SOUPRAVY
Hliník
Nerez
Mosaz
Plast

Vyobrazení	Obj. číslo	Čtyřhran			TS	Šroub	Kód barvy	Barevné provedení	Sklad	Cena brutto v Kč	
			SST								
Kótovaný náčrtek Str./ poz. 85/ 3	0810S/U10-100NM							NEW YORK			
	3286315	7/35	-	-	-	-	F1	Elox přírodní		440,-	
	3390892	7/35	-	-	-	-	F4	Elox bronz		498,-	
	3286331	7/35	-	-	-	-	F9	Elox ocel		807,-	
	3286374	7/35	-	-	-	-	F8707	Tmavohnědá lesklá		845,-	
	3286391	7/35	-	-	-	-	F9016	Bílá		422,-	
Kótovaný náčrtek Str./ poz. 85/ 3	0810S/U10/45°-100NM							NEW YORK			
	3470753	7/35	-	-	-	M5x45	F1	Elox přírodní		440,-	
	3470788	7/35	-	-	-	-	F4	Elox bronz		498,-	
	3470809	7/35	-	-	-	M5x45	F9	Elox ocel		498,-	
	3470817	7/35	-	-	-	M5x45	F9016	Bílá		422,-	



OKENNÍ KLIKY A BALKÓNOVÉ SOUPRAVY
Hliník
Nerez
Mosaz
Plast

Vyobrazení	Obj. číslo	Čtyřhran			TS	Šroub	Kód barvy	Barevné provedení	Sklad	Cena brutto v Kč	
			SST								
<i>Kótovaný náčrtek Str./ poz. 85/ 3</i>	0810S/U10/45°-100NM							NEW YORK			
	3750608	7/43	-	-	-	-	F1	Elox přírodní		440,-	
	3750632	7/43	-	-	-	-	F4	Elox bronz		498,-	
	3750683	7/43	-	-	-	-	F9	Elox ocel		498,-	
	3750510	7/43	-	-	-	-	F8707	Tmavohnědá lesklá		868,-	
	3750481	7/43	-	-	-	-	F9016	Bílá		422,-	
<i>Kótovaný náčrtek Str./ poz. 85/ 4</i>	0810S/U10-TBT1							NEW YORK			
	3286471	7/35	-	-	-	-	F1	Elox přírodní		961,-	
	3390913	7/35	-	-	-	-	F4	Elox bronz		1 043,-	
	3286497	7/35	-	-	-	-	F9	Elox ocel		1 043,-	
	3295967	7/35	-	-	-	-	F8707	Tmavohnědá lesklá		923,-	
	3286518	7/35	-	-	-	-	F9016	Bílá		923,-	



OKENNÍ KLIKY A BALKÓNOVÉ SOUPRAVY

Hliník

Nerez

Mosaz

Plast

Vyobrazení	Obj. číslo	Čtyřhran			TS	Šroub	Kód barvy	Barevné provedení	Sklad	Cena brutto v Kč
			SST							
<i>Kótovaný náčrtek Str./ poz. 85/ 5</i>	0810SV/U10	NEW YORK								
	3285566	7/35	-	-	-	-	F1	Elox přírodní	X	422,-
	3390930	7/35	-	-	-	-	F4	Elox bronz	X	450,-
	3285671	7/35	-	-	-	-	F9	Elox ocel	X	450,-
	3285697	7/35	-	-	-	-	F8707	Tmavohnědá lesklá	X	409,-
	3285718	7/35	-	-	-	-	F9016	Bílá	✓	264,-
<i>Kótovaný náčrtek Str./ poz. 85/ 5</i>	0810SV/U10/45°	NEW YORK								
	3751061	7/37	-	-	-	-	F1	Elox přírodní	X	446,-
	3751184	7/37	-	-	-	-	F4	Elox bronz	X	474,-
	3751213	7/37	-	-	-	-	F9	Elox ocel	X	474,-
	3750886	7/37	-	-	-	-	F8707	Tmavohnědá lesklá	X	433,-
	3750835	7/37	-	-	-	-	F9016	Bílá		188,-













OKENNÍ KLIKY A BALKÓNOVÉ SOUPRAVY
Hliník
Nerez
Mosaz
Plast

Vyobrazení	Obj. číslo	Čtyřhran			Šroub	Kód barvy	Barevné provedení	Sklad	Cena brutto v Kč	
			SST							
<i>Kótovaný nákres Str./ poz. 85/ 5</i>	0810SV/U10/45°						NEW YORK			
	3751070	7/43	-	-	-	F1	Elox přírodní		194,-	
	3751192	7/43	-	-	-	F4	Elox bronz		205,-	
	3751221	7/43	-	-	-	F9	Elox ocel		205,-	
	3750894	7/43	-	-	-	F8707	Tmavohnědá lesklá		433,-	
	3750843	7/43	-	-	-	F9016	Bílá		188,-	
<i>Kótovaný nákres Str./ poz. 85/ 6</i>	0810SVS/U10-DF						NEW YORK			
	3286585	7/35	-	-	-	F1	Elox přírodní		850,-	
	3390921	7/35	-	-	-	F4	Elox bronz		921,-	
	3286606	7/35	-	-	-	F9	Elox ocel		921,-	
	3286622	7/35	-	-	-	F8707	Tmavohnědá lesklá		817,-	
	3286649	7/35	-	-	-	F9016	Bílá		817,-	



OKENNÍ KLIKY A BALKÓNOVÉ SOUPRAVY
Hliník
Nerez
Mosaz
Plast

Vyobrazení	Obj. číslo	Čtyřhran			TS	Šroub	Kód barvy	Barevné provedení	Sklad	Cena brutto v Kč	
			SST								
Kótovaný nákres Str./ poz. 85/ 6	0810SVS/U10/45°-DF							NEW YORK			
 	3657833	7/40	-	-	-	-	F1	Elox přírodní	✓	421,-	
	3657841	7/40	-	-	-	-	F4	Elox bronz	✓	485,-	
	3657850	7/40	-	-	-	-	F9	Elox ocel	✓	485,-	
	3657868	7/40	-	-	-	-	F9016	Bílá	✓	401,-	
Kótovaný nákres Str./ poz. 85/ 6	0810SVS/U10/45°-DF							NEW YORK			
 	3480724	7/43	-	-	-	-	F1	Elox přírodní		421,-	
	3879575	7/43	-	-	-	-	F4	Elox bronz		485,-	
	3480732	7/43	-	-	-	-	F9	Elox ocel		485,-	
	3480741	7/43	-	-	-	-	F9016	Bílá		401,-	



OKENNÍ KLIKY A BALKÓNOVÉ SOUPRAVY
Hliník
Nerez
Mosaz
Plast

Vyobrazení	Obj. číslo	Čtyřhran		TS	Šroub	Kód barvy	Barevné provedení	Sklad	Cena brutto v Kč	
			SST							
<i>Kótovaný náčrtes Str./ poz. 86/ 1</i>	0810/961N/U10/0810/962NS/962PNS						NEW YORK			
	3273792	7	-	PZ	63-73	-	F1	Elox přírodní	✓	981,-
	3392960	7	-	PZ	63-73	-	F2	Elox alpaka	✗	1 134,-
	3382358	7	-	PZ	63-73	-	F4	Elox bronz	✓	1 078,-
	3273881	7	-	PZ	63-73	-	F9	Elox ocel	✓	1 078,-
	3273899	7	-	PZ	63-73	-	F8707	Tmavohnědá lesklá	✓	934,-
	3273901	7	-	PZ	63-73	-	F9016	Bílá	✓	934,-
<i>Kótovaný náčrtes Str./ poz. 86/ 1</i>	0810/961N/U10/0810/962NS/962PNS						NEW YORK			
	3461005	7	-	PZ	78-83	-	F1	Elox přírodní	✓	1 098,-
	3487029	7	-	PZ	78-83	-	F4	Elox bronz	✓	1 191,-
	3354461	7	-	PZ	78-83	-	F9	Elox ocel	✓	1 191,-
	3354550	7	-	PZ	78-83	-	F8707	Tmavohnědá lesklá	✗	1 211,-
	3354470	7	-	PZ	78-83	-	F9016	Bílá	✓	1 046,-





OKENNÍ KLIKY A BALKÓNOVÉ SOUPRAVY

Hliník

Nerez



Mosaz

Plast

Vyobrazení	Obj. číslo	Čtyřhran		TS	Šroub	Kód barvy	Barevné provedení	Sklad	Cena brutto v Kč	
			SST							
Kótovaný náčr. Str./ poz. 86/ 1	0810/961N/U10/0810/962NS/962PNS						NEW YORK			
	3653787	7	-	PZ	83-88	-	F1	Elox přírodní	✓	1 098,-
	3653795	7	-	PZ	83-88	-	F4	Elox bronz	✓	1 191,-
	3653808	7	-	PZ	83-88	-	F9	Elox ocel	✓	1 191,-
	3653816	7	-	PZ	83-88	-	F9016	Bílá	✓	1 046,-
Kótovaný náčr. Str./ poz. 86/ 2	099KH/961N/U10/0810/962NS/962PNS						NEW YORK			
	3273928	7	-	PZ	63-73	-	F1	Elox přírodní	✗	1 134,-
	3382420	7	-	PZ	63-73	-	F4	Elox bronz	✗	1 248,-
	3273936	7	-	PZ	63-73	-	F9	Elox ocel	✗	1 248,-
	3273944	7	-	PZ	63-73	-	F8707	Tmavohnědá lesklá	✗	1 081,-
	3273952	7	-	PZ	63-73	-	F9016	Bílá	✗	1 081,-



OKENNÍ KLIKY A BALKÓNOVÉ SOUPRAVY
Hliník
Nerez
Mosaz
Plast

Vyobrazení	Obj. číslo	Čtyřhran			TS	Šroub	Kód barvy	Barevné provedení	Sklad	Cena brutto v Kč	
			SST								
 <i>Kótovaný náčres Str./ poz. 86/ 3</i>	HS-0810/431N/422-UG							NEW YORK			
	3273362	10	-	UG	70-75	-	F1	Elox přírodní	✓	1 313,-	
	3387976	10	-	UG	70-75	-	F4	Elox bronz	✓	1 510,-	
	3273434	10	-	UG	70-75	-	F9	Elox ocel	✓	1 445,-	
	3273442	10	-	UG	70-75	-	F9016	Bílá	✓	1 250,-	
 <i>Kótovaný náčres Str./ poz. 86/ 4</i>	HS-0810/431N-PZ							NEW YORK			
	3273653	10	-	PZ/69	65-75	-	F1	Elox přírodní	✗	2 622,-	
	3388143	10	-	PZ/69	65-75	-	F4	Elox bronz	✗	2 884,-	
	3273661	10	-	PZ/69	65-75	-	F9	Elox ocel	✗	2 884,-	
	3273670	10	-	PZ/69	65-75	-	F9016	Bílá	✗	2 497,-	





OKENNÍ KLIKY A BALKÓNOVÉ SOUPRAVY

Vyobrazení	Obj. číslo	Čtyřhran			TS	Šroub	Kód barvy	Hliník	Nerez	Mosaz	Plast	
			SST					Barevné provedení	Sklad	Cena brutto v Kč		
 Kótovaný nákres Str./ poz. 86/ 5	PSK-0810/U10							NEW YORK				
	3371675	7/35	-	-	-	-	F1	Elox přírodní	✓		520,-	
	3390884	7/35	-	-	-	-	F4	Elox bronz	✓		517,-	
	3371683	7/35	-	-	-	-	F9	Elox ocel	✓		572,-	
	3371691	7/35	-	-	-	-	F9016	Bílá	✓		429,-	
 Kótovaný nákres Str./ poz. 86/ 5	PSK-0810/U10							NEW YORK				
	3455676	7/40	-	-	-	-	F1	Elox přírodní	✓		539,-	
	3455684	7/40	-	-	-	-	F9	Elox ocel	✓		590,-	
	3501601	7/40	-	-	-	-	F8707	Tmavohnědá lesklá	✗		659,-	
	3455692	7/40	-	-	-	-	F9016	Bílá	✓		445,-	







OKENNÍ KLIKY A BALKÓNOVÉ SOUPRAVY
Hliník
Nerez
Mosaz
Plast

Vyobrazení	Obj. číslo	Čtyřhran			TS	Šroub	Kód barvy	Barevné provedení	Sklad	Cena brutto v Kč	
			SST								
<i>Kótovaný náčrtek Str./ poz. 86/ 6</i>	PSK-0810S/U10-100NM							NEW YORK			
	3371641	7/35	-	-	-	-	F1	Elox přírodní	X	1 257,-	
	3390796	7/35	-	-	-	-	F4	Elox bronz	X	1 341,-	
	3371659	7/35	-	-	-	-	F9	Elox ocel	X	1 341,-	
	3371667	7/35	-	-	-	-	F9016	Bílá	X	1 179,-	
<i>Kótovaný náčrtek Str./ poz. 86/ 6</i>	PSK-0810S/U10-100NM							NEW YORK			
	3481006	7/43	-	-	-	-	F1	Elox přírodní	X	1 276,-	
	3500553	7/45	-	-	-	-	F4	Elox bronz	X	1 360,-	
	3481014	7/43	-	-	-	-	F9	Elox ocel	X	1 360,-	
	3481031	7/43	-	-	-	-	F8707	Tmavohnědá lesklá	X	1 198,-	
	3481022	7/43	-	-	-	-	F9016	Bílá	X	1 198,-	







OKENNÍ KLIKY A BALKÓNOVÉ SOUPRAVY

							Hliník	Nerez	Mosaz	Plast
Vyobrazení	Obj. číslo	Čtýřhran		TS	Šroub	Kód barvy	Barevné provedení	Sklad	Cena brutto v Kč	
			SST							
	Kótovaný náčres Str./ poz. 87/ 1						PSK-037/U11			
	PARIS									
	2113738	7/35	-	-	-	-	F1	Elox přírodní	X	934,-
	808922	7/35	-	-	-	-	F4	Elox bronz	X	1 052,-
	2218601	7/35	-	-	-	-	F9	Elox ocel	X	1 045,-
761104	7/35	-	-	-	M5x40	F9016	Bílá	X	947,-	
Kótovaný náčres Str./ poz. 87/ 2							E038/US956			
PARIS										
  	2049932	7/35	-	-	-	-	F69	Nerez matná	X	1 754,-



OKENNÍ KLIKY A BALKÓNOVÉ SOUPRAVY
Hliník
Nerez
Mosaz
Plast

Vyobrazení	Obj. číslo	Čtyřhran			TS	Šroub	Kód barvy	Barevné provedení	Sklad	Cena brutto v Kč	
			SST								
 	E038/US956							PARIS			
	1932803	7/40	-	-	-	-	F69	Nerez matná	X	1 762,-	
 	E038/US956/45°							PARIS			
	2620166	7/35	-	-	-	-	F69	Nerez matná	X	1 759,-	





OKENNÍ KLIKY A BALKÓNOVÉ SOUPRAVY

Hliník

Nerez

Mosaz

Plast

Vyobrazení	Obj. číslo	Čtyřhran		TS	Šroub	Kód barvy	Barevné provedení	Sklad	Cena brutto v Kč	
			SST							
<i>Kótovaný náčres Str./ poz. 87/ 3</i>	HS-E038Z/431N/422-UG						PARIS			
	2619675	10	-	UG	70-75	-	F69/F32-1	Nerez matná/elox nerez	X	5 080,-
<i>Kótovaný náčres Str./ poz. 87/ 4</i>	HS-E038Z/431N-PZ						PARIS			
	2619683	10	-	PZ/69	55-75	-	F69	Nerez matná	X	9 696,-



OKENNÍ KLIKY A BALKÓNOVÉ SOUPRAVY
Hliník
Nerez
Mosaz
Plast

Vyobrazení	Obj. číslo	Čtyřhran			TS	Šroub	Kód barvy	Barevné provedení	Sklad	Cena brutto v Kč
			SST							
 <i>Kótovaný náčres Str./ poz. 87/ 5</i>	0756/U26-7/45°							SALVADOR		
	3751272	7/43	-	-	-	M5x55	F9016	Bílá	✓	46,-
 <i>Kótovaný náčres Str./ poz. 87/ 6</i>	E0140/US956							STOCKHOLM		
	3037167	7/35	-	-	-	-	F69	Nerez matná	✗	1 084,-







OKENNÍ KLIKY A BALKÓNOVÉ SOUPRAVY

Hliník

Nerez

Mosaz

Plast

Vyobrazení	Obj. číslo	Čtýřhran			TS	Šroub	Kód barvy	Barevné provedení	Sklad	Cena brutto v Kč	
			SST								
Kótovaný náčres Str./ poz. 87/ 6	E0140/US956							STOCKHOLM			
	3668647	7/43	-	-	-	M5x55	F69	Nerez matná	X	1 090,-	
Kótovaný náčres Str./ poz. 87/ 6	E0140/US956/45°							STOCKHOLM			
	3571992	7/35	-	-	-	-	F69	Nerez matná	X	1 090,-	

















OKENNÍ KLIKY A BALKÓNOVÉ SOUPRAVY
Hliník
Nerez
Mosaz
Plast

Vyobrazení	Obj. číslo	Čtyřhran			TS	Šroub	Kód barvy	Barevné provedení	Sklad	Cena brutto v Kč
			SST							
<i>Kótovaný náčres Str./ poz. 88/ 1</i>	0710/U26	TOKYO								
	1788021	7/35	-	-	-	M5x45	F1	Elox přírodní	X	310,-
	1755771	7/35	-	-	-	M5x45	F2	Elox alpaka	X	310,-
	1895820	7/35	-	-	-	M5x45	F4	Elox bronz	X	338,-
	8157836	7/35	-	-	-	M5x45	F9	Elox ocel	X	332,-
	1931430	7/35	-	-	-	M5x45	F8707	Tmavohnědá lesklá	X	310,-
	8167512	7/35				M5x45	F9016	Bílá		73,-
<i>Kótovaný náčres Str./ poz. 88/ 1</i>	0710/U26	TOKYO								
	2147081	7/40	-	-	-	M5x50	F1	Elox přírodní	X	315,-
	2770949	7/40	-	-	-	M5x50	F4	Elox bronz	X	338,-
	2759459	7/40	-	-	-	M5x50	F9	Elox ocel	X	338,-
	2040671	7/40	-	-	-	M5x50	F8707	Tmavohnědá lesklá	X	315,-
	2040663	7/40	-	-	-	M5x50	F9016	Bílá	X	315,-



OKENNÍ KLIKY A BALKÓNOVÉ SOUPRAVY
Hliník
Nerez
Mosaz
Plast

Vyobrazení	Obj. číslo	Čtyřhran			TS	Šroub	Kód barvy	Barevné provedení	Sklad	Cena brutto v Kč	
			SST								
<i>Kótovaný náčres Str./ poz. 88/ 1</i>	0710/U26/45°							TOKYO			
	1925929	7/35	-	-	-	M5x45	F1	Elox přírodní		73,-	
	1925937	7/35	-	-	-	-	F2	Elox alpaka		73,-	
	1925953	7/35	-	-	-	M5x45	F4	Elox bronz		84,-	
	1925961	7/35	-	-	-	M5x45	F9	Elox ocel		80,-	
	2351171	7/35	-	-	-	M5x45	F8707	Tmavohnědá lesklá		73,-	
	1759393	7/35	-	-	-	M5x45	F9016	Bílá		73,-	
<i>Kótovaný náčres Str./ poz. 88/ 1</i>	0710/U26/45°							TOKYO			
	2427180	7/40	-	-	-	M5x50	F1	Elox přírodní		73,-	
	2729639	7/40	-	-	-	M5x50	F4	Elox bronz		84,-	
	2988518	7/40	-	-	-	M5x50	F9	Elox ocel		80,-	
	2732660	7/40	-	-	-	M5x50	F8707	Tmavohnědá lesklá		73,-	
	2552440	7/40	-	-	-	M5x50	F9016	Bílá		73,-	



OKENNÍ KLIKY A BALKÓNOVÉ SOUPRAVY
Hliník
Nerez
Mosaz
Plast

Vyobrazení	Obj. číslo	Čtyřhran			TS	Šroub	Kód barvy	Barevné provedení	Sklad	Cena brutto v Kč
			SST							
<i>Kótovaný nákres Str./ poz. 88/ 2</i>	0710S/U26	TOKYO								
	8164535	7/35	-	-	-	-	F1	Elox přírodní	X	756,-
	1902997	7/35	-	-	-	-	F2	Elox alpaka	X	756,-
	1903009	7/35	-	-	-	-	F4	Elox bronz	X	848,-
	8156499	7/35	-	-	-	-	F9	Elox ocel	X	848,-
	1748459	7/35	-	-	-	-	F8707	Tmavohnědá lesklá	X	756,-
	8156507	7/35	-	-	-	-	F9016	Bílá		466,-
<i>Kótovaný nákres Str./ poz. 88/ 2</i>	0710S/U26/45°	TOKYO								
	2930957	7/35	-	-	-	M5x45	F1	Elox přírodní		630,-
	1873575	7/35	-	-	-	-	F4	Elox bronz		709,-
	1917646	7/35	-	-	-	-	F9	Elox ocel	X	709,-
	2397321	7/35	-	-	-	-	F8707	Tmavohnědá lesklá	X	775,-
	2006756	7/35	-	-	-	-	F9016	Bílá		466,-





OKENNÍ KLIKY A BALKÓNOVÉ SOUPRAVY

Hliník

Nerez

Mosaz

Plast

Vyobrazení	Obj. číslo	Čtyřhran			TS	Šroub	Kód barvy	Barevné provedení	Sklad	Cena brutto v Kč	
			SST								
Kótovaný náčres Str./ poz. 88/ 2	0710S/U26/45°							TOKYO			
	2314185	7/40	-	-	-	-	F1	Elox přírodní	X	768,-	
	2912476	7/40	-	-	-	M5x50	F4	Elox bronz	X	872,-	
	3008032	7/40	-	-	-	M5x50	F9	Elox ocel	X	872,-	
	2314513	7/40	-	-	-	-	F9016	Bílá		466,-	
Kótovaný náčres Str./ poz. 88/ 3	0710SV/U26							TOKYO			
	1747536	7/35	-	-	-	-	F1	Elox přírodní	X	420,-	
	1747552	7/35	-	-	-	-	F4	Elox bronz	X	461,-	
	1747561	7/35	-	-	-	-	F9	Elox ocel	X	461,-	
	1747579	7/35	-	-	-	-	F8707	Tmavohnědá lesklá	X	420,-	
	1747587	7/35	-	-	-	-	F9016	Bílá	X	420,-	

















OKENNÍ KLIKY A BALKÓNOVÉ SOUPRAVY
Hliník
Nerez
Mosaz
Plast

Vyobrazení	Obj. číslo	Čtyřhran			TS	Šroub	Kód barvy	Barevné provedení	Sklad	Cena brutto v Kč	
			SST								
Kótovaný náčres Str./ poz. 88/ 3	0710SV/U26							TOKYO			
	2748928	7/40	-	-	-	M5x50	F1	Elox přírodní	X	439,-	
	2952081	7/40	-	-	-	M5x50	F9	Elox ocel	X	480,-	
	2748936	7/40	-	-	-	M5x50	F9016	Bílá	X	439,-	
Kótovaný náčres Str./ poz. 88/ 3	0710SV/U26/45°							TOKYO			
	2871969	7/35	-	-	-	M5x45	F1	Elox přírodní	X	439,-	
	2187260	7/35	-	-	-	M5x45	F4	Elox bronz		335,-	
	2122651	7/35	-	-	-	-	F9	Elox ocel	X	467,-	
	2122642	7/35	-	-	-	-	F9016	Bílá		242,-	



OKENNÍ KLIKY A BALKÓNOVÉ SOUPRAVY
Hliník
Nerez
Mosaz
Plast

Vyobrazení	Obj. číslo	Čtyřhran			TS	Šroub	Kód barvy	Barevné provedení	Sklad	Cena brutto v Kč	
			SST								
Kótovaný náčres Str./ poz. 88/ 3	0710SV/U26/45°							TOKYO			
	2927299	7/40	-	-	-	M5x50	F1	Elox přírodní		445,-	
	2868014	7/40	-	-	-	M5x50	F4	Elox bronz		486,-	
	2743406	7/40	-	-	-	M5x50	F8707	Tmavohnědá lesklá		445,-	
	2868006	7/40	-	-	-	M5x50	F9016	Bílá		445,-	
Kótovaný náčres Str./ poz. 88/ 4	0710RH/66N/U26/0710/66NS/49PNS							TOKYO			
	8137416	7	-	PZ	63-68	-	F1	Elox přírodní		976,-	
	8137432	7	-	PZ	63-68	-	F2	Elox alpaka		1 129,-	
	8137440	7	-	PZ	63-68	-	F4	Elox bronz		1 122,-	
	8137457	7	-	PZ	63-68	-	F9	Elox ocel		1 122,-	
	8137473	7	-	PZ	63-68	-	F8707	Tmavohnědá lesklá		1 298,-	
	8137481	7	-	PZ	63-68	-	F9016	Bílá		1 122,-	







OKENNÍ KLIKY A BALKÓNOVÉ SOUPRAVY
Hliník
Nerez
Mosaz
Plast

Vyobrazení	Obj. číslo	Čtyřhran		TS	Šroub	Kód barvy	Barevné provedení	Sklad	Cena brutto v Kč	
			SST							
<i>Kótovaný náčrtek Str./ poz. 88/ 4</i>	0710RH/66N/U26/0710/66NS/49PNS					TOKYO				
	2059410	7	-	PZ	78-83	-	F1	Elox přírodní	X	1 283,-
	2059428	7	-	PZ	78-83	-	F4	Elox bronz	X	1 434,-
	2059436	7	-	PZ	78-83	-	F9	Elox ocel	X	1 434,-
	2170812	7	-	PZ	78-83	-	F8707	Tmavohnědá lesklá	X	1 433,-
	2059452	7	-	PZ	78-83	-	F9016	Bílá	X	1 434,-
<i>Kótovaný náčrtek Str./ poz. 88/ 5</i>	099KH/66N/U26/0710/66NS/49PNS					TOKYO				
	8127318	7	-	PZ	63-68	-	F1	Elox přírodní	X	1 129,-
	8127391	7	-	PZ	63-68	-	F4	Elox bronz	X	1 298,-
	8127409	7	-	PZ	63-68	-	F9	Elox ocel	X	1 298,-
	8127425	7	-	PZ	63-68	-	F8707	Tmavohnědá lesklá	X	1 298,-
	8127433	7	-	PZ	63-68	-	F9016	Bílá		1 122,-



OKENNÍ KLIKY A BALKÓNOVÉ SOUPRAVY
Hliník
Nerez
Mosaz
Plast

Vyobrazení	Obj. číslo	Čtyřhran			TS	Šroub	Kód barvy	Barevné provedení	Sklad	Cena brutto v Kč	
			SST								
Kótovaný náčrtek Str./ poz. 88/ 6	0710LRH/U71Z							TOKYO			
	2871555	7/35	-	-	-	-	F1	Elox přírodní	X	483,-	
	2606719	7/50	-	-	-	-	F4	Elox bronz	X	444,-	
	2606971	7/50	-	-	-	-	F9016	Bílá	X	444,-	
Kótovaný náčrtek Str./ poz. 89/ 1	0710LVK/U71Z							TOKYO			
	2606760(L)	7/40	-	-	-	-	F1	Elox přírodní	X	456,-	
	2606778(P)	7/40	-	-	-	-	F1	Elox přírodní	X	456,-	
	3521645(L)	7/60	-	-	-	-	F4	Elox bronz	X	509,-	
	3521637(P)	7/60	-	-	-	-	F4	Elox bronz	X	509,-	
	2611180(L)	7/40	-	-	-	-	F9016	Bílá	X	456,-	
	2611198(P)	7/40	-	-	-	-	F9016	Bílá	X	456,-	







OKENNÍ KLIKY A BALKÓNOVÉ SOUPRAVY
Hliník
Nerez
Mosaz
Plast

Vyobrazení	Obj. číslo	Čtýřhran			TS	Šroub	Kód barvy	Barevné provedení	Sklad	Cena brutto v Kč
			SST							
<i>Kótovaný náčres Str./ poz. 89/ 2</i>	0710ES/6	TOKYO								
	2607009	7/40	-	-	-	-	F1	Elox přírodní	X	946,-
	2535130	7/40	-	-	-	-	F4	Elox bronz	X	1 059,-
	2607017	7/40	-	-	-	-	F9016	Bílá	X	944,-
<i>Kótovaný náčres Str./ poz. 89/ 3</i>	E0430/US956	TRONDHEIM								
 Secustik® 	2273651	7/35	-	-	-	-	F69	Nerez matná	X	1 003,-
	2657217	7/40	-	-	-	-	F69	Nerez matná	X	1 008,-



OKENNÍ KLIKY A BALKÓNOVÉ SOUPRAVY
Hliník
Nerez
Mosaz
Plast



Vyobrazení	Obj. číslo	Čtyřhran			TS	Šroub	Kód barvy	Barevné provedení	Sklad	Cena brutto v Kč	
			SST								
Kótovaný náčres Str./ poz. 89/ 4	0510/U26/45°							VERONA			
	3519238	7/35	-	-	-	M5x45	F1	Elox přírodní	X	364,-	
	3519246	7/35	-	-	-	M5x45	F4	Elox bronz	X	394,-	
	2656960	7/35	-	-	-	-	F9	Elox ocel	X	381,-	
	3519220	7/35	-	-	-	M5x45	F9016	Bílá	X	364,-	
Kótovaný náčres Str./ poz. 89/ 5	E0800/US956							VERONA			
	2072868	7/35	-	-	-	-	F69	Nerez matná	X	2 034,-	





R.S.P. s.r.o.

OKENNÍ KLIKY A BALKÓNOVÉ SOUPRAVY

							Hliník	Nerez	Mosaz	Plast
Vyobrazení	Obj. číslo	Čtyřhran		TS	Šroub	Kód barvy	Barevné provedení	Sklad	Cena brutto v Kč	
			SST							
 <p>Resista® 10-letá záruka na povrchovou úpravu</p>	M051/U26						VERONA			
	661114	7/35	-	-	-	F71	Mosaz lesklá		612,-	
	763061	7/35	-	-	-	F98-R	Chrom matný-Resista®		1 212,-	
 <p>45°</p>	M051/U26/45°						VERONA			
	3194648	7/35	-	-	-	F71	Mosaz lesklá		617,-	

© R.S.P. s.r.o. Týn nad Vltavou

Verze: HOP-SP-06.14









Platnost od: 15.03.2014

Tisk: 01.03.2014

Technické změny vyhrazeny!



OKENNÍ KLIKY A BALKÓNOVÉ SOUPRAVY
Hliník
Nerez
Mosaz
Plast

Vyobrazení	Obj. číslo	Čtyřhran			Šroub	Kód barvy	Barevné provedení	Sklad	Cena brutto v Kč	
			SST							
Kótovaný nákres Str./ poz. 90/ 1	SG0710RH						TOKYO			
	1776281	7/45	-	-	-	F9016	Bílá	✓	124,-	
Kótovaný nákres Str./ poz. 90/ 2	U26SV									
	672240	-	-	-	-	F1	Elox přírodní		207,-	
	780266	-	-	-	-	F4	Elox bronz		239,-	
	811601	-	-	-	-	F9	Elox ocel		239,-	
	736010	-	-	-	-	F8707	Tmavohnědá lesklá		207,-	
	1721504	-	-	-	-	F9016	Bílá	✓	179,-	



OKENNÍ KLIKY A BALKÓNOVÉ SOUPRAVY
Hliník
Nerez
Mosaz
Plast

Vyobrazení	Obj. číslo	Čtyřhran			TS	Šroub	Kód barvy	Barevné provedení	Sklad	Cena brutto v Kč
			SST							
<i>Kótovaný nákres Str./ poz. 90/ 3</i>	430/70									
	672585	-	-	-	-	-	F1	<i>Elox přírodní</i>		153,-
	517022	-	-	-	-	-	F2	<i>Elox alpaka</i>		153,-
	517039	-	-	-	-	-	F4	<i>Elox bronz</i>		175,-
	2214037	-	-	-	-	-	F9	<i>Elox ocel</i>		175,-
	517046	-	-	-	-	-	F9016	<i>Bílá</i>		179,-
<i>Kótovaný nákres Str./ poz. 90/ 4</i>	K435									
	544318	-	-	-	-	-	F8019M	<i>Šedohnědá matná</i>		277,-
	544301	-	-	-	-	-	F9003M	<i>Bílá matná</i>		277,-





OKENNÍ KLIKY A BALKÓNOVÉ SOUPRAVY - NÁKRESY

Hliník

Nerez

Mosaz

Plast

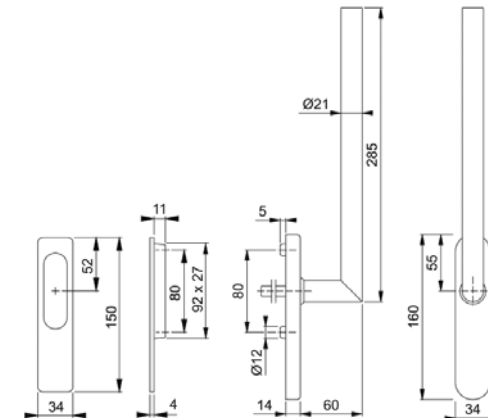
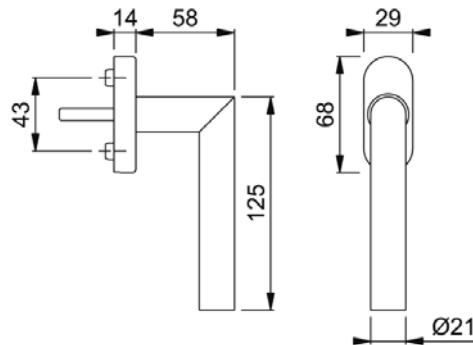
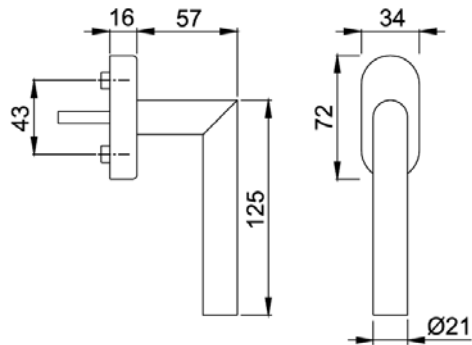

AMSTERDAM
E0400/US956

(79/ 1)

AMSTERDAM
E0400/U30

(79/ 2)

AMSTERDAM
HS-E0400Z/431N/422-UG

(79/ 3)

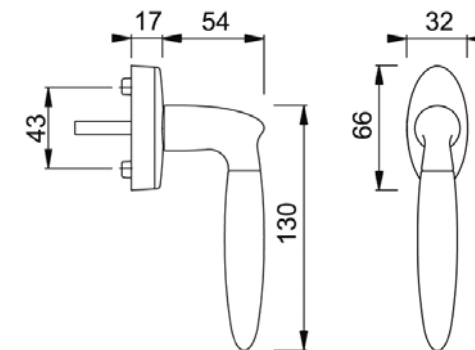
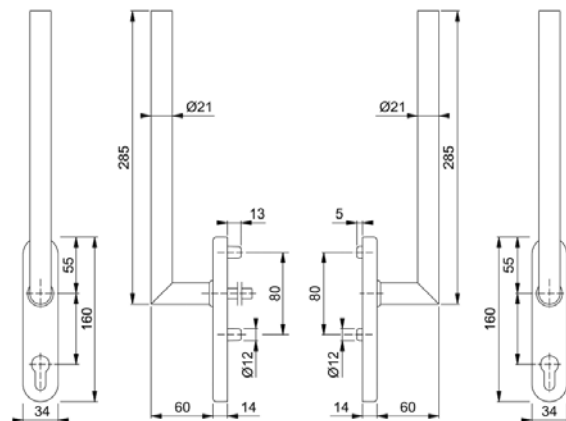
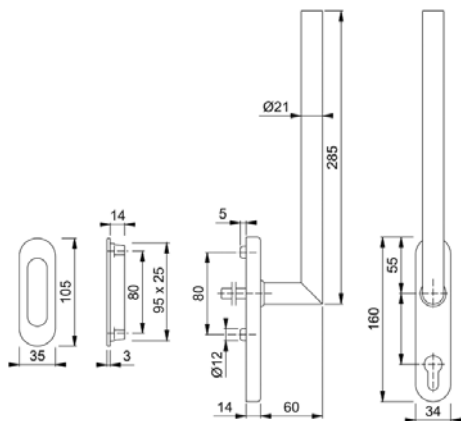

AMSTERDAM
HS-E0400Z/431N/422-PZ

(79/ 4)

AMSTERDAM
HS-E0400Z/431N-PZ

(79/ 5)

ATHINAI
M056/U937

(79/ 6)





R.S.P. s.r.o.

OKENNÍ KLIKY A BALKÓNOVÉ SOUPRAVY - NÁKRESY

Hliník

Nerez

Mosaz

Plast

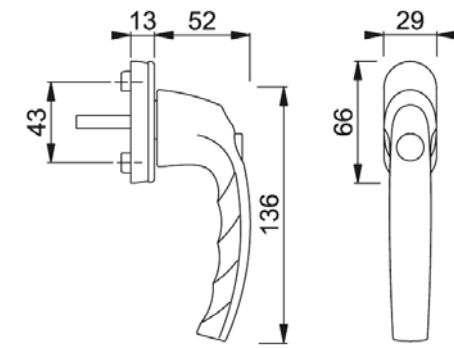
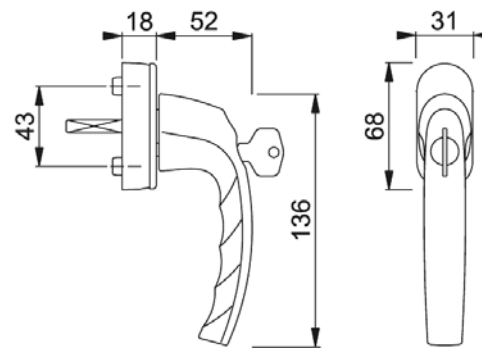
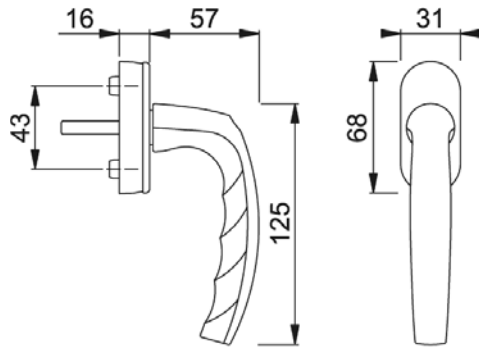

ATLANTA
0530/US952(45°)

(80/ 1)

ATLANTA
0530S/US952(45°)

(80/ 2)

ATLANTA
0530SV/U26(45°)

(80/ 3)

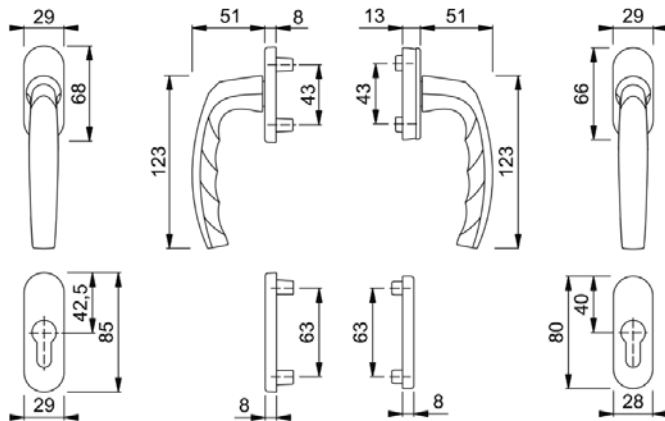

ATLANTA
0530/66N/U26/0530/66NS/49PNS

(80/ 4)

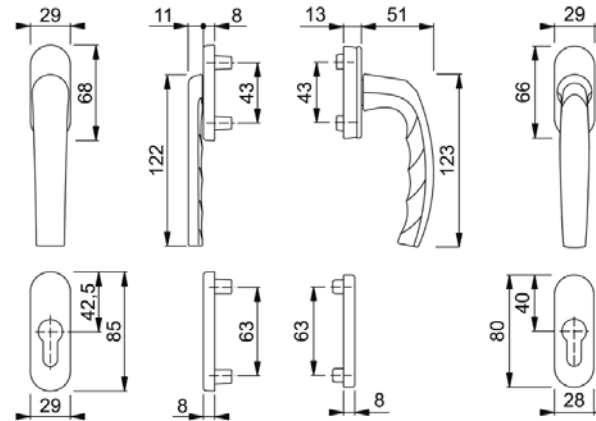

ATLANTA
0990KH/66N/U26/0530/66NS/49PNS

(80/ 5)

ATLANTA
PSK-0530/US952-1

(80/ 6)

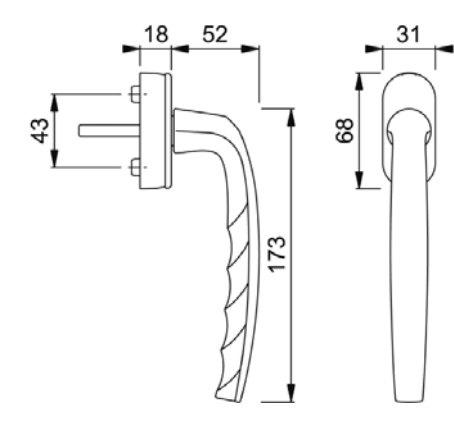



OKENNÍ KLIKY A BALKÓNOVÉ SOUPRAVY - NÁKRESY

Hliník

Nerez

Mosaz

Plast

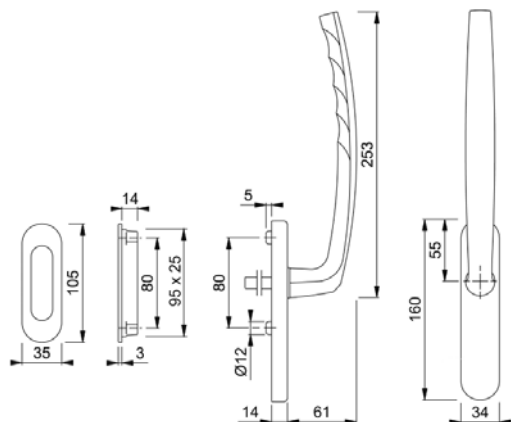

ATLANTA
HS-0530/431N/422-UG

(81/ 1)

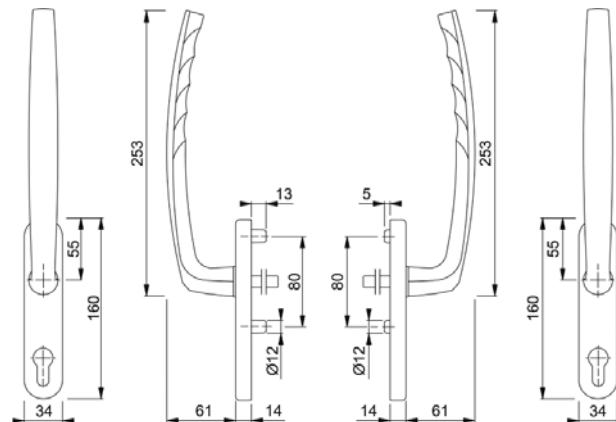

ATLANTA
HS-0530/431N-PZ

(81/ 2)

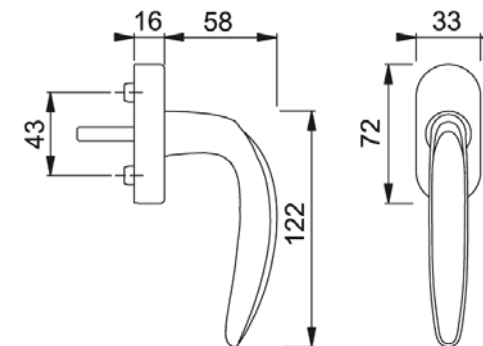

ATLANTA
M0530/US956(45°)

(81/ 3)

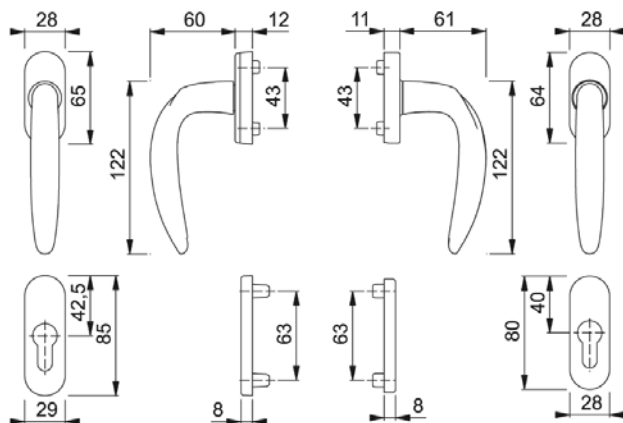

ATLANTA
M0530/U61/U23/0530/66NS/49PNS

(81/ 4)

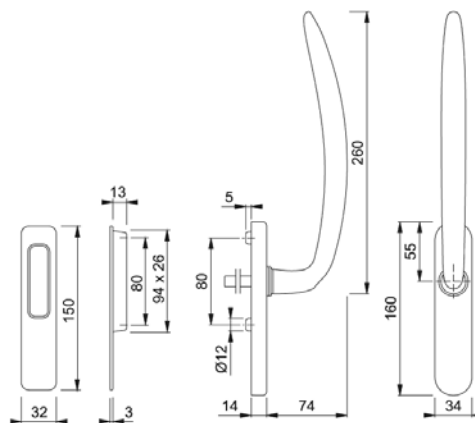

ATLANTA
HS-M0530/431N/423-UG

(81/ 5)

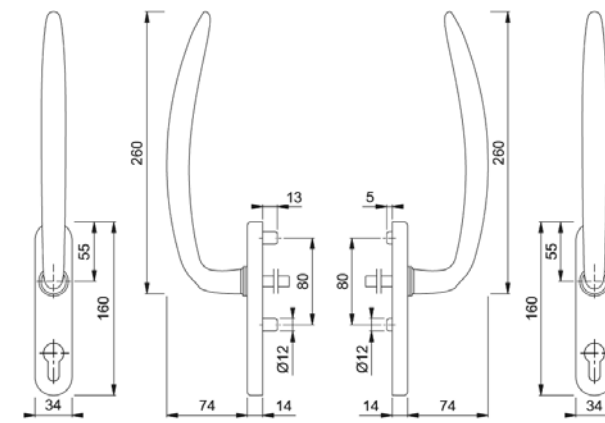

ATLANTA
HS-M0530/431N-PZ

(81/ 6)





R.S.P. s.r.o.

OKENNÍ KLIKY A BALKÓNOVÉ SOUPRAVY - NÁKRESY

Hliník

Nerez

Mosaz

Plast

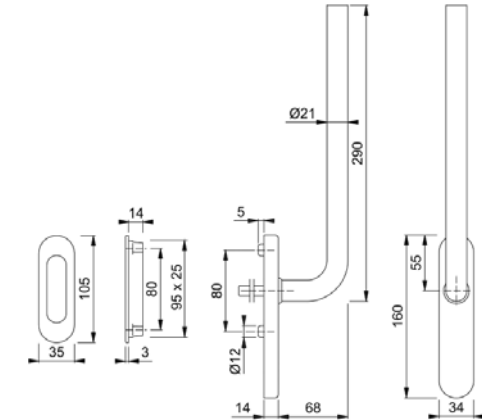
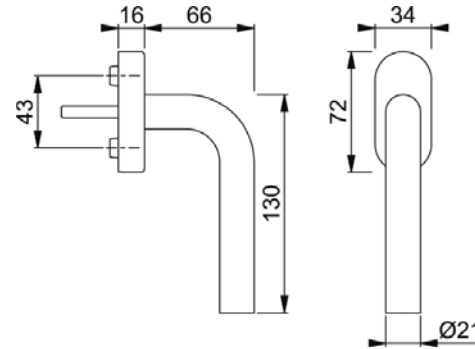
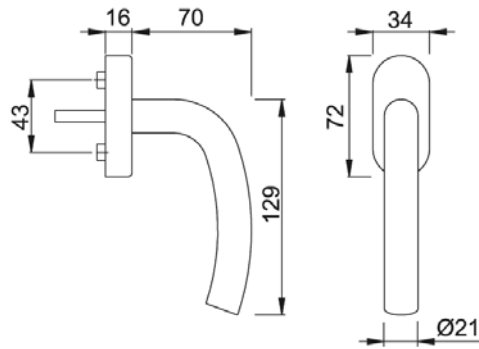

BILBAO
E0365/US956

(82/ 1)

BONN
E050/US956(45°)

(82/ 2)

BONN
HS-E050Z/431N/422-UG

(82/ 3)

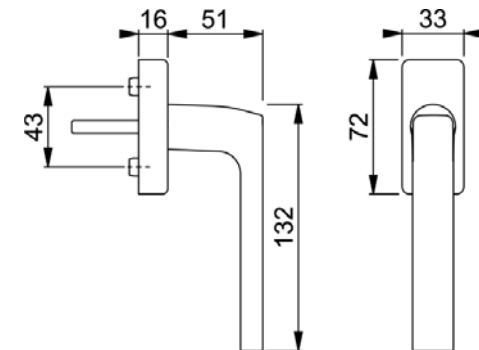
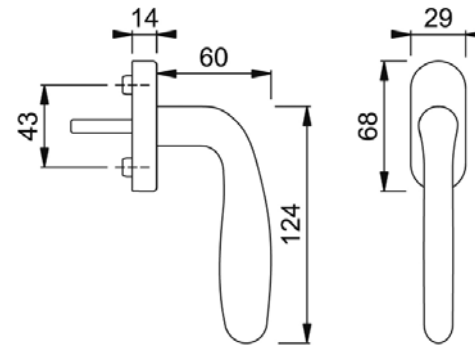
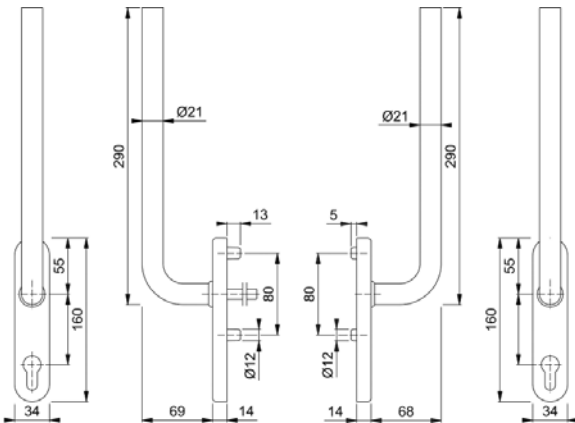

BONN
HS-E050Z/431N-PZ

(82/ 4)

CARDIFF
E0850/U30

(82/ 5)

DALLAS
E0643/US944

(82/ 6)

© R.S.P. s.r.o. Týn nad Vltavou

Verze: HOP-SP-06.14

Platnost od: 15.03.2014

Tisk: 01.03.2014

Technické změny vyhrazeny!





OKENNÍ KLIKY A BALKÓNOVÉ SOUPRAVY - NÁKRESY

Hliník

Nerez

Mosaz

Plast

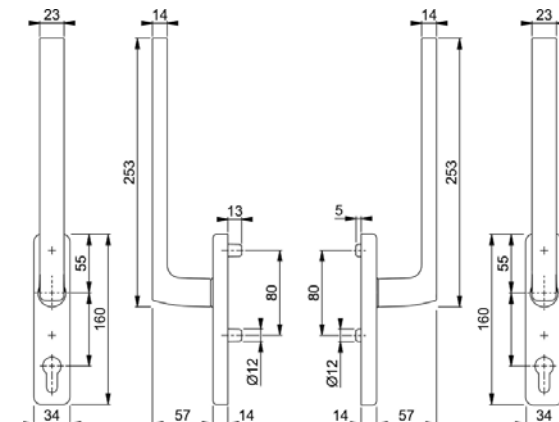
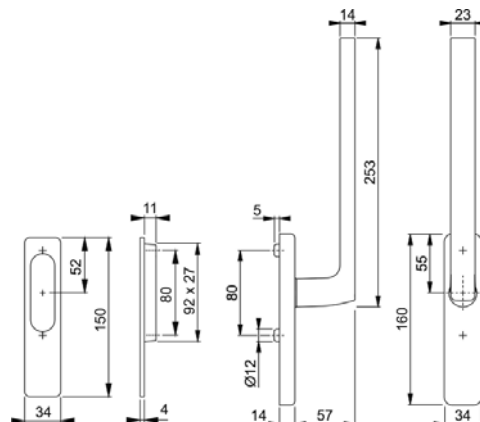
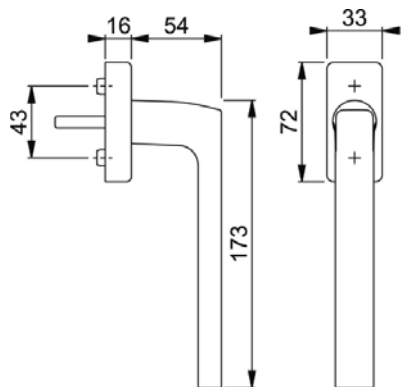

DALLAS
PSK-0643/US944/45°

(83/ 1)

DALLAS
HS-0643/419/420-UG

(83/ 2)

DALLAS
HS-0643/419-PZ

(83/ 3)

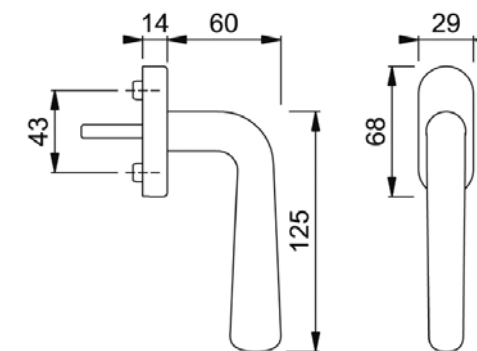
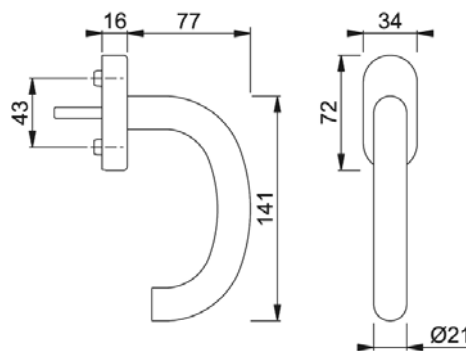
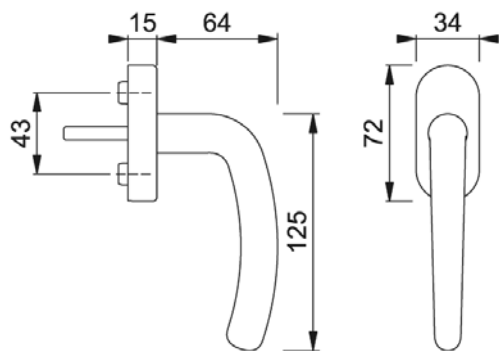

DENVER
E0310/US956

(83/ 4)

GÖTEBORG
E0410/US956

(83/ 5)

HELSINGBORG
E0730/U30

(83/ 6)





R.S.P. s.r.o.

OKENNÍ KLIKY A BALKÓNOVÉ SOUPRAVY - NÁKRESY

Hliník

Nerez

Mosaz

Plast

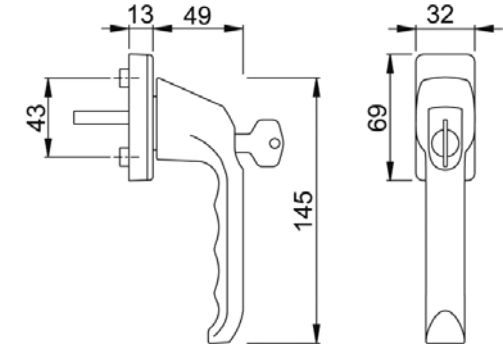
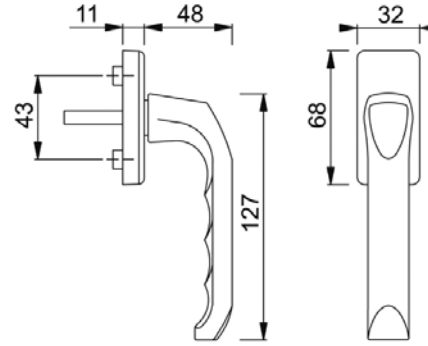
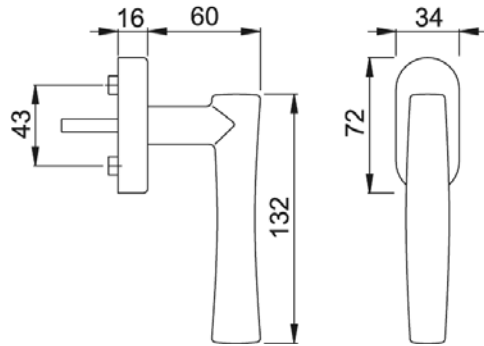

LAS VEGAS
E0440/US956

(84/ 1)

LONDON
M013/U11Z(45°)

(84/ 2)

LONDON
M013S/U11Z

(84/ 3)

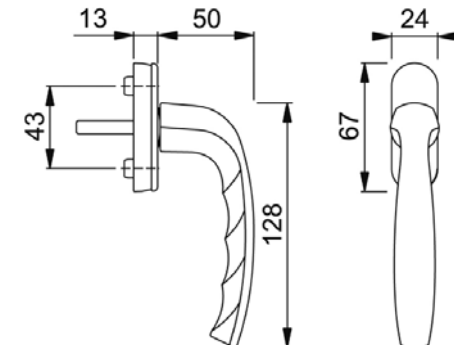
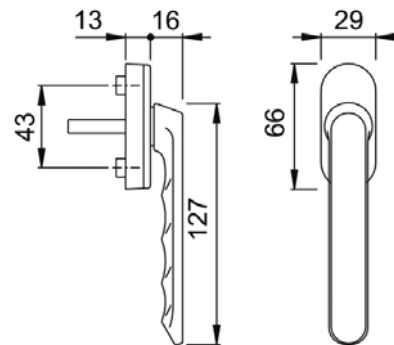
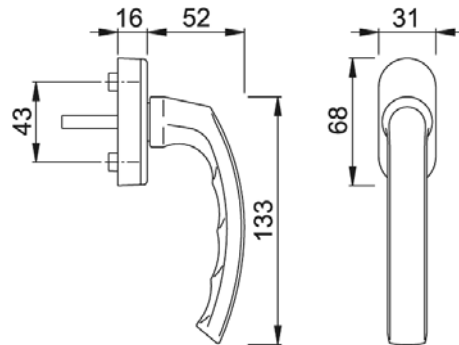

LUXEMBOURG
099/US952(45°)

(84/ 4)

LUXEMBOURG
099KH/U26

(84/ 5)

NEW YORK
0810/U76

(84/ 6)

© R.S.P. s.r.o. Týn nad Vltavou

Verze: HOP-SP-06.14

Platnost od: 15.03.2014

Tisk: 01.03.2014

Technické změny vyhrazeny!

84

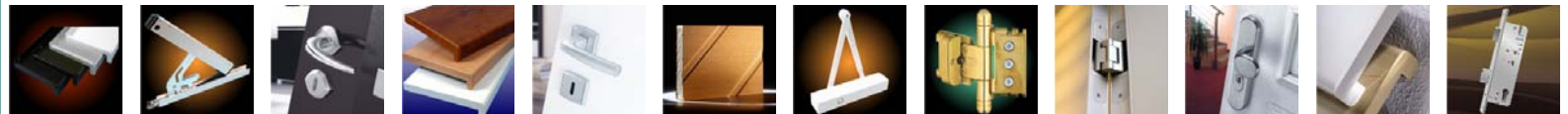



OKENNÍ KLIKY A BALKÓNOVÉ SOUPRAVY - NÁKRESY

Hliník Nerez Mosaz Plast

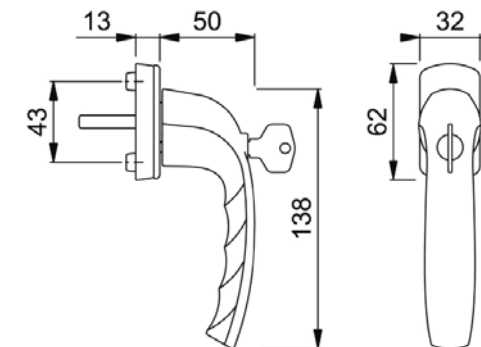
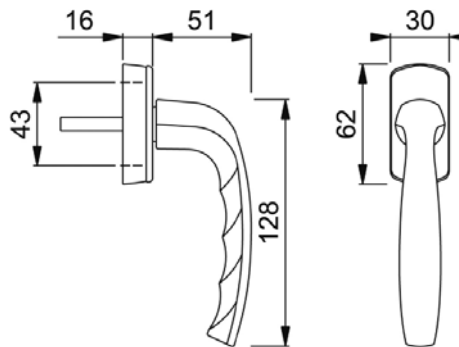
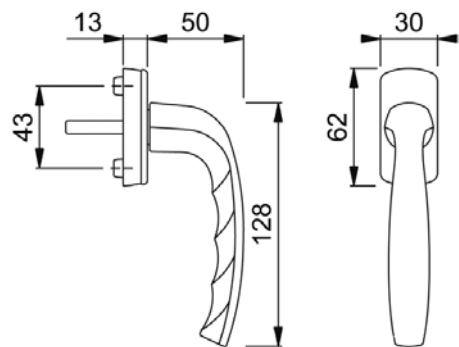

NEW YORK
0810/U10(45°)

(85/ 1)

NEW YORK
0810/US10(45°)

(85/ 2)

NEW YORK
0810S/U10(45°)

(85/ 3)

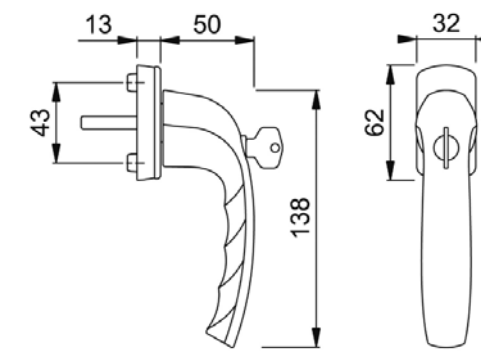
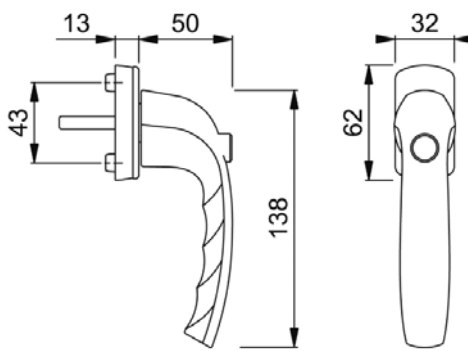
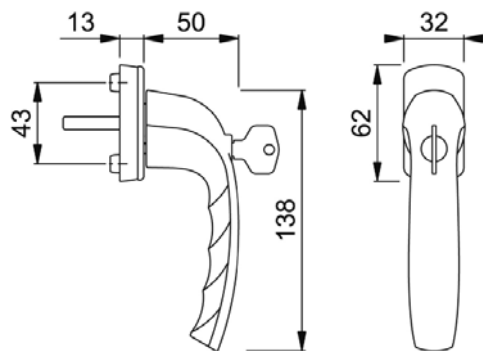

NEW YORK
0810S/U10-TBT1

(85/ 4)

NEW YORK
0810SV/U10(45°)

(85/ 5)

NEW YORK
0810SVS/U10(45°)-DF

(85/ 6)





R.S.P. s.r.o.

OKENNÍ KLIKY A BALKÓNOVÉ SOUPRAVY - NÁKRESY

Hliník

Nerez

Mosaz

Plast

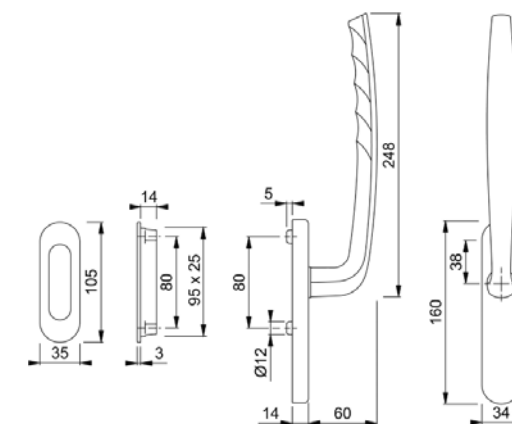
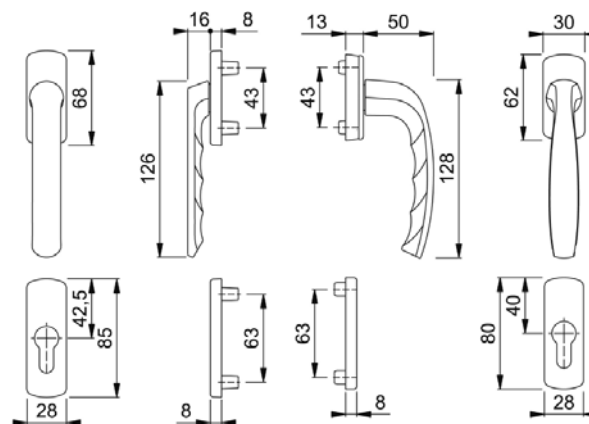
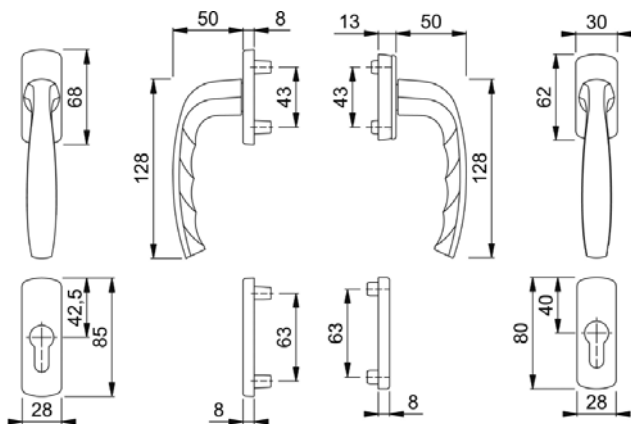

NEW YORK

(86/ 1)

0810/961N/U10/0810/962NS/962PNS

NEW YORK

(86/ 2)

099KH/961N/U10/0810/962NS/962PNS

NEW YORK

(86/ 3)

HS-0810/431N/422-UG

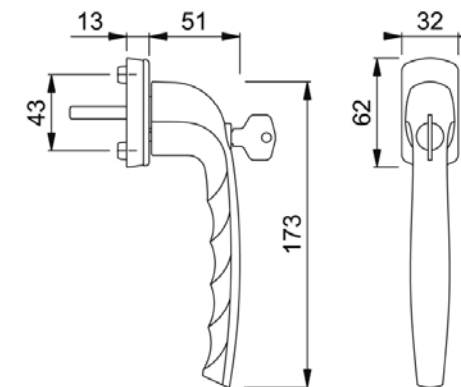
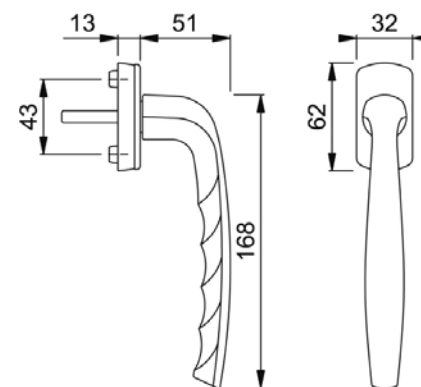
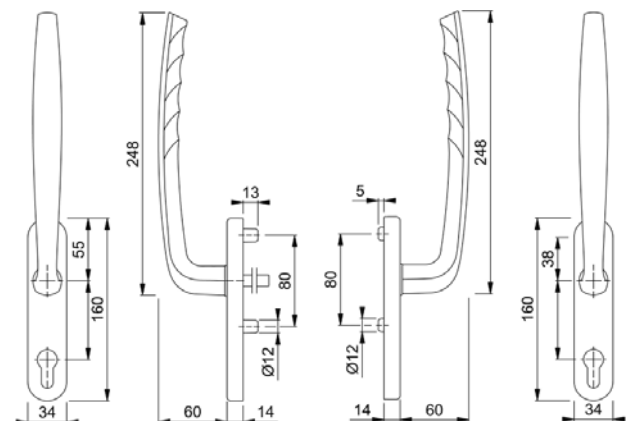

NEW YORK

(86/ 4)

HS-0810/431N-PZ

NEW YORK

(86/ 5)

PSK-0810/U10

NEW YORK

(86/ 6)

PSK-0810S/U10

© R.S.P. s.r.o. Týn nad Vltavou

Verze: HOP-SP-06.14

Platnost od: 15.03.2014

Tisk: 01.03.2014

Technické změny vyhrazeny!

86



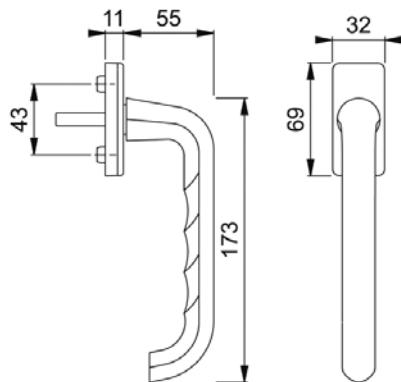

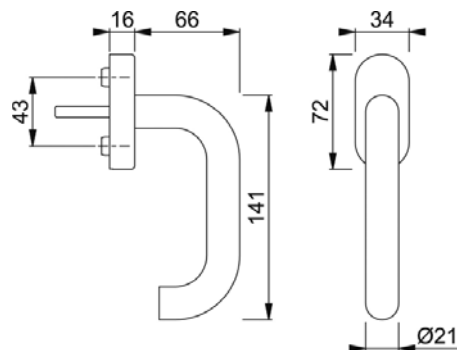
OKENNÍ KLIKY A BALKÓNOVÉ SOUPRAVY - NÁKRESY
Hliník
Nerez
Mosaz
Plast

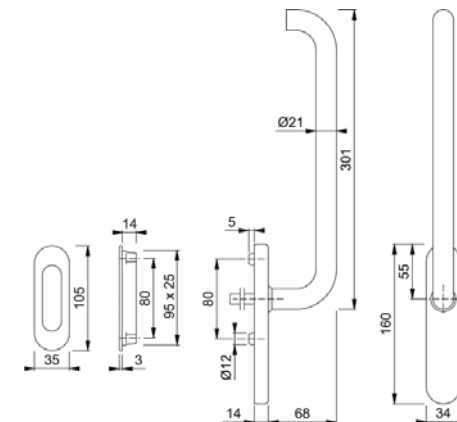
PARIS
PSK-037/U11

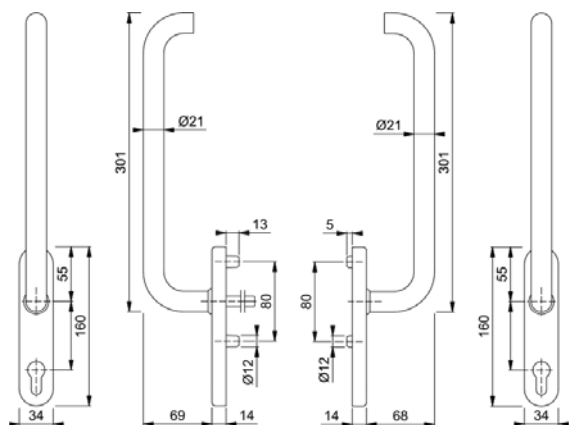
(87/ 1)

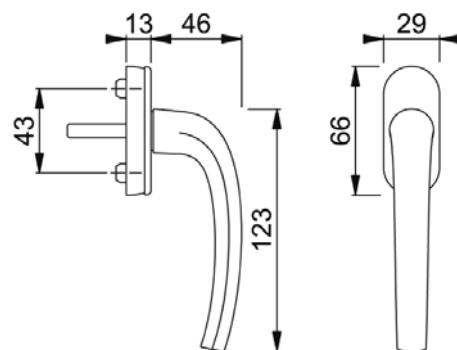
PARIS
E038/US956(45°)

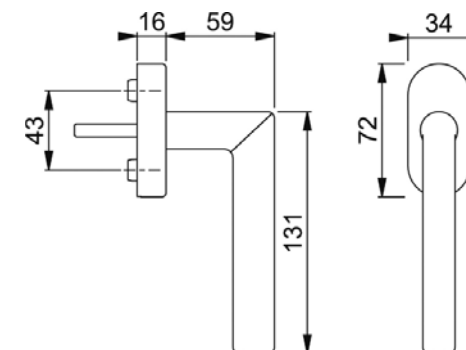
(87/ 2)

PARIS
HS-E038Z/431N/422-UG

(87/ 3)

PARIS
HS-E038Z/431N-PZ

(87/ 4)

SALVADOR
0756/U26-7(45°)

(87/ 5)

STOCKHOLM
E0140/US956(45°)

(87/ 6)



R.S.P. s.r.o.

OKENNÍ KLIKY A BALKÓNOVÉ SOUPRAVY - NÁKRESY

Hliník

Nerez

Mosaz

Plast

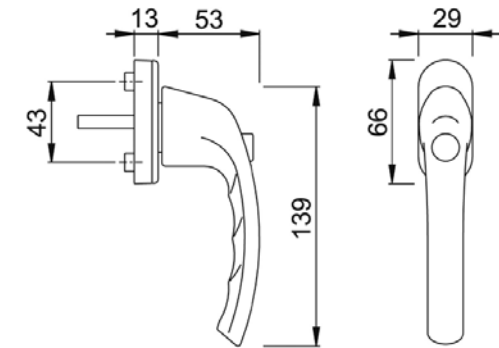
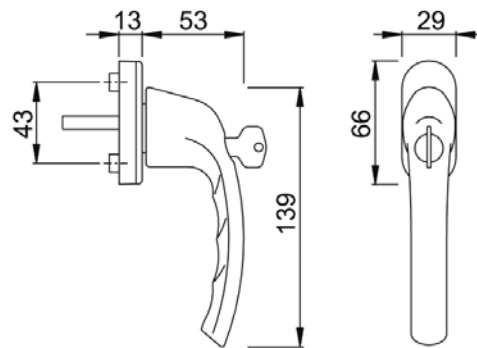
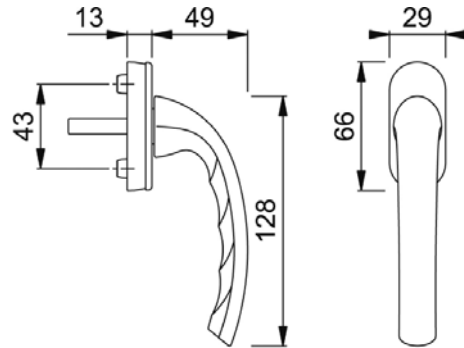

TOKYO
0710/U26(45°)

(88/ 1)

TOKYO
0710S/U26(45°)

(88/ 2)

TOKYO
0710SV/U26(45°)

(88/ 3)

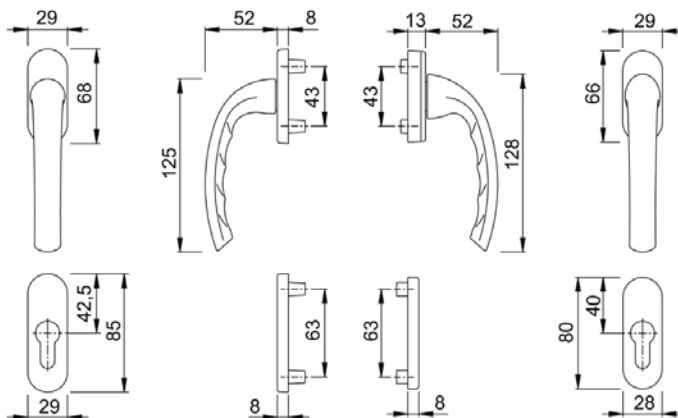

TOKYO
0710RH/66N/U26/0710/66NS/49PNS

(88/ 4)

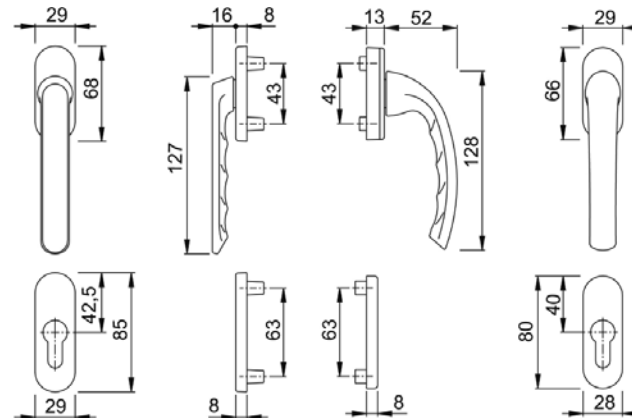

TOKYO
099KH/66N/U26/0710/66NS/49PNS

(88/ 5)

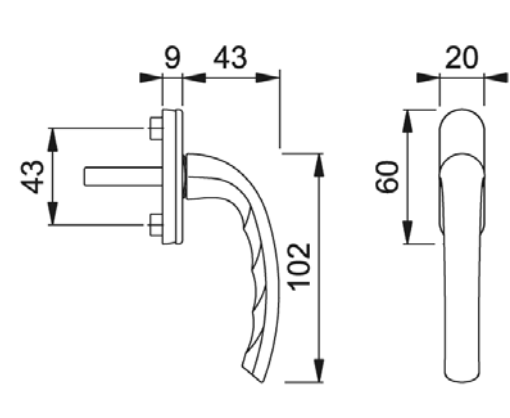

TOKYO
0710LRH/U71Z

(88/ 6)

© R.S.P. s.r.o. Týn nad Vltavou

Verze: HOP-SP-06.14

Platnost od: 15.03.2014

Tisk: 01.03.2014

Technické změny vyhrazeny!

88

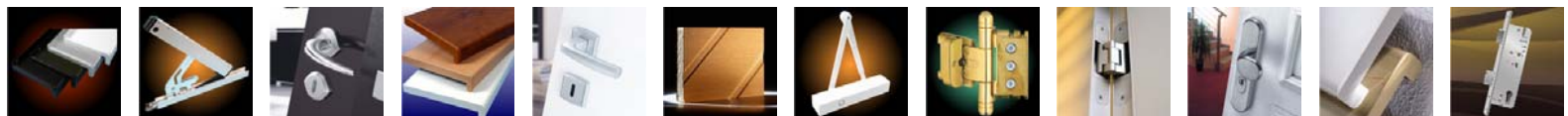



OKENNÍ KLIKY A BALKÓNOVÉ SOUPRAVY - NÁKRESY

Hliník

Nerez

Mosaz

Plast

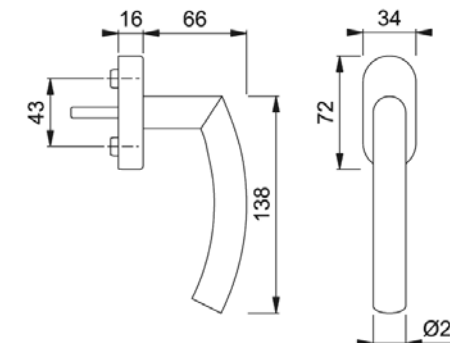
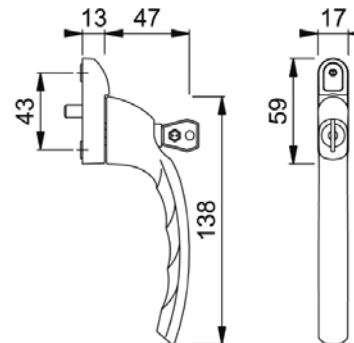
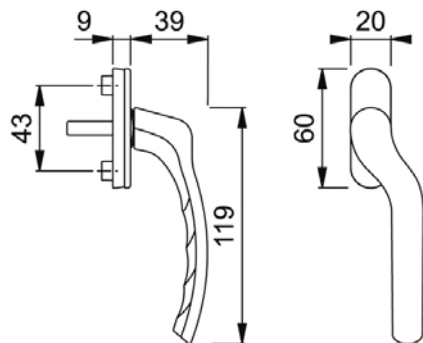

TOKYO
0710LVK/U71Z(L/P)

(89/ 1)

TOKYO
0710ES/6

(89/ 2)

TRONDHEIM
E0430/US956

(89/ 3)

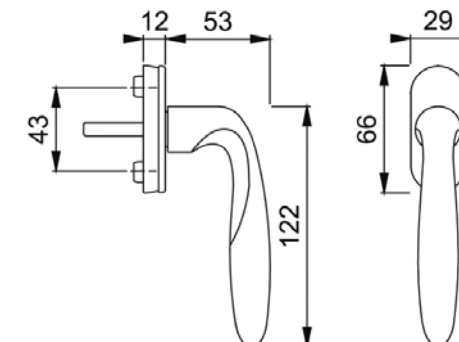
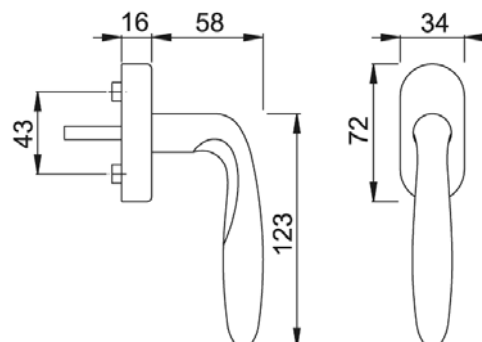
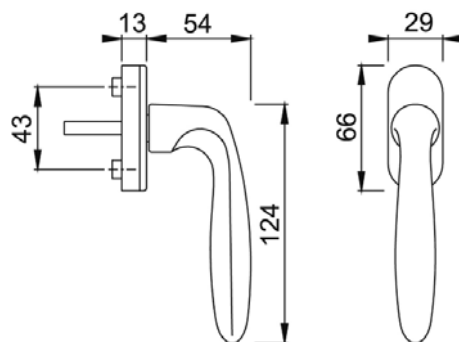

VERONA
0510/U26(45°)

(89/ 4)

VERONA
E0800/US956

(89/ 5)

VERONA
M051/U26(45°)

(89/ 6)

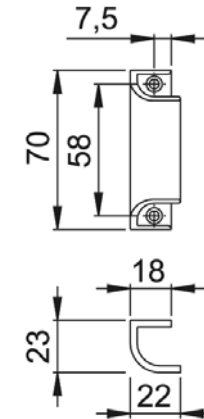
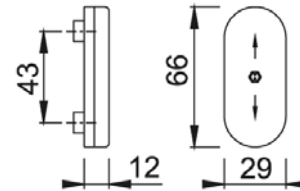
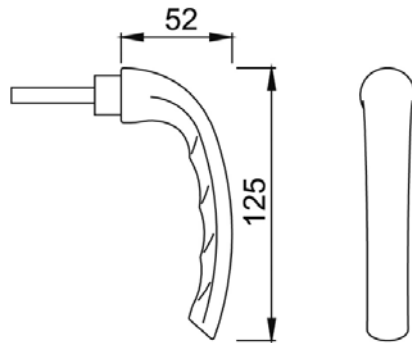

OKENNÍ KLIKY A BALKÓNOVÉ SOUPRAVY - NÁKRESY
Hliník
Nerez
Mosaz
Plast

TOKYO
SG0710RH

(90/ 1)

U26SV

(90/ 2)

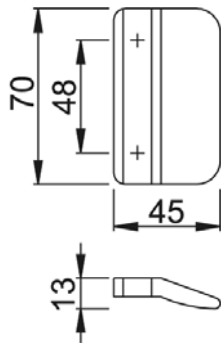
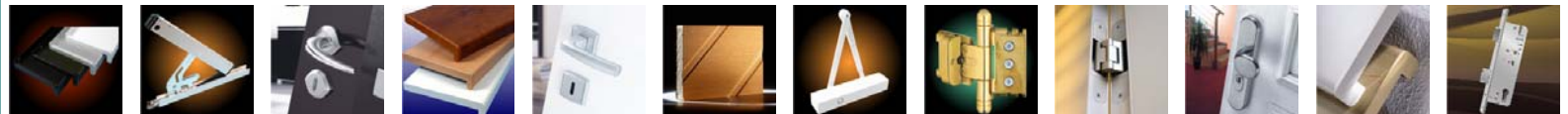
430/70

(90/ 3)

(90/ 4)
K 435

SOUPRAVY PRO PROFILOVÉ DVEŘE
Hliník
Nerez
Mosaz
Plast

ATLANTA 1530	92-93	PARIS E138GF	133-134
ATLANTA M1530	93-97	TOKYO 1710RH	135-138
DENVER E1310Z	98-99	Kótované nákresy	139-152
LIVERPOOL 1313G	100-104		
LIVERPOOL E1313G	105-109		
LIVERPOOL M1313G	110-114		
LONDON 113	115-116		
LUXEMBOURG 1500	117-121		
MARSEILLE 1138	122		
MARSEILLE E1138	122		
MÜNCHEN M112SH	123		
NEW YORK 1810	124-132		







SOUPRAVY PRO PROFILOVÉ DVEŘE

								Hliník	Nerez	Mosaz	Plast
Vyobrazení	Obj. číslo	Čtýřhran		TS	Šroub	Kód barvy	Barevné provedení	Sklad	Cena brutto v Kč		
			SST								
Kótovaný nákres Str./ poz. 139/ 1	1530/3359ZA/3357N-RF					Tt2	ATLANTA		36 MM		
	2417395	8/125	-	PZ/92	67-72	M6x80	F1-2	Elox přírodní matný	X	2 726,-	
	2760193	8/125	-	PZ/92	67-72	M6x80	F4	Elox bronz	X	3 135,-	
	2698481	8/125	-	PZ/92	67-72	M6x80	F9	Elox ocel	X	3 135,-	
	2417432	8/125	-	PZ/92	67-72	M6x80	F9016	Bílá	X	2 726,-	
<i>Poznámka: montážní sady pro jinou tloušťku dveří - strana 153/ poz.1.</i>											
Kótovaný nákres Str./ poz. 139/ 2	86G/3359ZA/3357N-RF/1530					Tt2	ATLANTA		36 MM		
	2417109	8/110	-	PZ/92	67-72	M6x80	F1-2	Elox přírodní matný	X	2 726,-	
	2760441	8/110	-	PZ/92	67-72	M6x80	F4	Elox bronz	X	3 135,-	
	2417133	8/110	-	PZ/92	67-72	M6x80	F9	Elox ocel	X	3 135,-	
	2417168	8/110	-	PZ/92	67-72	M6x80	F9016	Bílá	X	2 726,-	
<i>Poznámka: montážní sady pro jinou tloušťku dveří - strana 153/ poz.2.</i>											





SOUPRAVY PRO PROFILOVÉ DVEŘE
Hliník
Nerez
Mosaz
Plast

Vyobrazení	Obj. číslo	Čtyřhran		TS	Šroub	Kód barvy	Barevné provedení	Sklad	Cena brutto v Kč	
			SST							
<i>Kótovaný náčrsek Str./ poz. 139/ 3</i>	513G/3359ZA/3357N-RF/1530					Tt2	ATLANTA		36 MM	
	2416704	8/*	-	PZ/92	67-72	M6x80	F1-2	Elox přírodní matný	X	2 726,-
	2775344	8/*	-	PZ/92	67-72	M6x80	F4	Elox bronz	X	3 135,-
	2698457	8/*	-	PZ/92	67-72	M6x80	F9	Elox ocel	X	3 135,-
	2416851	8/*	-	PZ/92	67-72	M6x80	F9016	Barva bílá	X	2 726,-
*) Poznámka: čtyřhran 40mm je pevně nalisovaný v klice.										
<i>Kótovaný náčrsek Str./ poz. 139/ 4</i>	M1530/3357N-RF						ATLANTA		35 MM	
	2767580	8/145	-	PZ/92	67-72	M6x80	F71	Mosaz lesklá		4 050,-
	2767598	8/145	-	PZ/92	67-72	M6x80	F73	Mosaz brynýrovaná	X	4 050,-
	2767601	8/145	-	PZ/92	67-72	M6x80	F77-R	Mosaz lesklá- Resista [®]	X	4 611,-
Poznámka: montážní sady pro jinou tloušťku dveří - strana 153/ poz.1.										





SOUPRAVY PRO PROFILOVÉ DVEŘE

								Hliník	Nerez	Mosaz	Plast
Vyobrazení	Obj. číslo	Čtyřhran		TS	Šroub	Kód barvy	Barevné provedení	Sklad	Cena brutto v Kč		
			SST								
 <p>Resista 10-letá záruka na povrchovou úpravu</p>	M86G/3357N/3357N-RF/1530						ATLANTA		35 MM		
	2767854	8/100	-	PZ/92	67-72	M6x80	F71	Mosaz lesklá	X	4 901,-	
	2767862	8/100	-	PZ/92	67-72	M6x80	F73	Mosaz brynýrovaná	X	4 901,-	
	2767871	8/100	-	PZ/92	67-72	M6x80	F77-R	Mosaz lesklá- Resista ®	X	5 463,-	
<i>Poznámka: montážní sady pro jinou tloušťku dveří - strana 153/ poz.2.</i>											
	M551G/3357N/3357N-RF/1530						ATLANTA		35 MM		
	2768224	8/*	-	PZ/92	67-72	**	F71	Mosaz lesklá	X	4 901,-	
	2768232	8/*	-	PZ/92	67-72	**	F73	Mosaz brynýrovaná	X	4 901,-	
	2768241	8/*	-	PZ/92	67-72	**	F77-R	Mosaz lesklá- Resista ®	X	5 463,-	
<i>*) Poznámka: čtyřhran 40mm je pevně nalisovaný v klice.</i>											
<i>***) Poznámka: šroub M6x100mm-2ks a šroub M6x80mm-1ks</i>											



SOUPRAVY PRO PROFILOVÉ DVEŘE
Hliník
Nerez
Mosaz
Plast

Vyobrazení	Obj. číslo	Čtyřhran		TS	Šroub	Kód barvy	Barevné provedení	Sklad	Cena brutto v Kč
			SST						
 <p>BEZPEČNOSTNÍ TŘÍDA Tb2 ČSN EN 1627 ČSN EN 1630</p> <p>Resista® 10-letá záruka na povrchovou úpravu</p>	M1530/3358/3357N-RF						Tt2	ATLANTA	35 MM
	2766683	8/145	-	PZ/92	67-72	M6x80	F77-R	Mosaz lesklá- Resista®	X
<i>Poznámka: montážní sady pro jinou tloušťku dveří - strana 153/ poz.1.</i>									
 <p>BEZPEČNOSTNÍ TŘÍDA Tb2 ČSN EN 1627 ČSN EN 1630</p> <p>Resista® 10-letá záruka na povrchovou úpravu</p>	M86G/3358/3357N-RF/1530						Tt2	ATLANTA	35 MM
	2766659	8/100	-	PZ/92	67-72	M6x80	F77-R	Mosaz lesklá- Resista®	X
<i>Poznámka: montážní sady pro jinou tloušťku dveří - strana 153/ poz.2.</i>									





SOUPRAVY PRO PROFILOVÉ DVEŘE

							Hliník	Nerez	Mosaz	Plast
Vyobrazení	Obj. číslo	Čtyřhran		TS	Šroub	Kód barvy	Barevné provedení	Sklad	Cena brutto v Kč	
			SST							
 	M551G/3358/3357N-RF/1530						Tt2	ATLANTA		35 MM
	2764581	8/*	-	PZ/92	67-72	M6x80	F77-R	Mosaz lesklá-Resista®	X	6 062,-
<i>*) Poznámka: čtyřhran 40mm je pevně nalisovaný v klíče.</i>										
 	M1530/3359ZA/3357N-RF						Tt2	ATLANTA		35 MM
	2764442	8/145	-	PZ/92	67-72	M6x80	F77-R	Mosaz lesklá-Resista®	X	6 933,-
<i>Poznámka: montážní sady pro jinou tloušťku dveří - strana 153/ poz.1.</i>										







SOUPRAVY PRO PROFILOVÉ DVEŘE
Hliník
Nerez
Mosaz
Plast

Vyobrazení	Obj. číslo	Čtyřhran		TS	Šroub	Kód barvy	Barevné provedení	Sklad	Cena brutto v Kč
			SST						
 <p>BEZPEČNOSTNÍ TŘÍDA Tb2 ČSN EN 1627 ČSN EN 1630</p> <p>Resista® 10-letá záruka na povrchovou úpravu</p>	M86G/3359ZA/3357N-RF/1530						Tt2	ATLANTA	35 MM
	2764240	8/110	-	PZ/92	67-72	M6x80	F77-R	Mosaz lesklá- Resista®	X
<i>Poznámka: montážní sady pro jinou tloušťku dveří - strana 153/ poz.2.</i>									
 <p>BEZPEČNOSTNÍ TŘÍDA Tb2 ČSN EN 1627 ČSN EN 1630</p> <p>Resista® 10-letá záruka na povrchovou úpravu</p>	M551G/3359ZA/3357N-RF/1530						Tt2	ATLANTA	35 MM
	2763829	8/*	-	PZ/92	67-72	M6x80	F77-R	Mosaz lesklá- Resista®	X
<i>*) Poznámka: čtyřhran 40mm je pevně nalisovaný v klice.</i>									



SOUPRAVY PRO PROFILOVÉ DVEŘE

							Hliník	Nerez	Mosaz	Plast
Vyobrazení	Obj. číslo	Čtyřhran			TS	Šroub	Kód barvy	Barevné provedení	Sklad	Cena brutto v Kč
			SST							
	E1310Z/3346							DENVER		30 MM
	2497891	8/140	-	PZ/92	67-72	M6x80	F69	Nerez matná	✓	1 176,-
	E86G/3346/1310Z							DENVER		30 MM
	2498324	8/100	-	PZ/92	67-72	M6x80	F69	Nerez matná	✓	1 524,-







SOUPRAVY PRO PROFILOVÉ DVEŘE

Hliník

Nerez

Mosaz

Plast

Vyobrazení	Obj. číslo	Čtyřhran		TS	Šroub	Kód barvy	Barevné provedení	Sklad	Cena brutto v Kč
			SST						
 <small>Kótovaný náčr. Str./ poz. 141/ 3</small>	E554G/3346/1310Z						DENVER		30 MM
	2797244	8/60	-	PZ/92	67-72	M6x80	F69	Nerez matná	X
 <small>Kótovaný náčr. Str./ poz. 141/ 4</small>	E099KH/3346/1310Z						DENVER		30 MM
	2797287	8/120	-	PZ/92	67-72	M6x80	F69	Nerez matná	X



SOUPRAVY PRO PROFILOVÉ DVEŘE

Vyobrazení	Obj. číslo	Čtýřhran			TS	Šroub	Kód barvy	Hliník	Nerez	Mosaz	Plast
			SST					Barevné provedení	Sklad	Cena brutto v Kč	

Kótovaný náčrtek Str./ poz. 141/ 5

1313G/3357N-RF
LIVERPOOL
36 MM

2971097	*	-	PZ/92	-	*	F1-2	Elox přírodní matný		983,-
3475538	*	-	PZ/92	-	*	F4	Elox bronz		1 129,-
2971100	*	-	PZ/92	-	*	F9	Elox ocel		1 129,-
2971118	*	-	PZ/92	-	*	F8707	Tmavohnědá lesklá		983,-
2971126	*	-	PZ/92	-	*	F9016	Bílá		983,-

*) Poznámka: montážní sada není součástí balení.

Poznámka: montážní sady pro jinou tloušťku dveří - strana 153/ poz.1.

Kótovaný náčrtek Str./ poz. 141/ 5

1313G/3357N-RF
LIVERPOOL
36 MM

3462665	8/145	-	PZ/92	72-77	M6x85	F1-2	Elox přírodní matný		1 020,-
3462690	8/145	-	PZ/92	72-77	M6x85	F4	Elox bronz		1 020,-
3393866	8/145	-	PZ/92	72-77	M6x85	F9	Elox ocel		1 165,-
3393794	8/145	-	PZ/92	72-77	M6x85	F8707	Tmavohnědá lesklá		1 020,-
3393823	8/145	-	PZ/92	72-77	M6x85	F9016	Bílá		1 165,-
3475124	8/145	-	PZ/92	72-77	M6x85	F4/F9016	Elox bronz/ Bílá		1 103,-

Poznámka: montážní sady pro jinou tloušťku dveří - strana 153/ poz.1.







SOUPRAVY PRO PROFILOVÉ DVEŘE

Vyobrazení	Obj. číslo	Čtýřhran		TS	Šroub	Kód barvy	Barevné provedení	Sklad	Cena brutto v Kč
			SST						

Kótovaný náčrsek Str./ poz. 141/ 6

86G/3357N/3357N-RF/1313G
LIVERPOOL
36 MM







2971054	*	-	PZ/92	-	*	F1-2	Elox přírodní matný		1 387,-
3475706	*	-	PZ/92	-	*	F4	Elox bronz		1 595,-
2971062	*	-	PZ/92	-	*	F9	Elox ocel		1 595,-
2971071	*	-	PZ/92	-	*	F8707	Tmavohnědá lesklá		1 387,-
2971089	*	-	PZ/92	-	*	F9016	Barva Bílá		1 387,-

*) Poznámka: montážní sada není součástí balení.

Poznámka: montážní sady pro jinou tloušťku dveří - strana 153/ poz.2.

Kótovaný náčrsek Str./ poz. 141/ 6

86G/3357N/3357N-RF/1313G
LIVERPOOL
36 MM



3462753	8/100	-	PZ/92	72-77	M6x85	F1-2	Elox přírodní matný		1 424,-
3462761	8/100	-	PZ/92	72-77	M6x85	F4	Elox bronz		1 632,-
3393946	8/100	-	PZ/92	72-77	M6x85	F9	Elox ocel		1 631,-
3393891	8/100	-	PZ/92	72-77	M6x85	F8707	Tmavohnědá lesklá		1 424,-
3393903	8/100	-	PZ/92	72-77	M6x85	F9016	Bílá		1 424,-
3475132	8/100	-	PZ/92	72-77	M6x85	F4/F9016	Elox bronz/ Bílá		1 632,-

Poznámka: montážní sady pro jinou tloušťku dveří - strana 153/ poz.2.





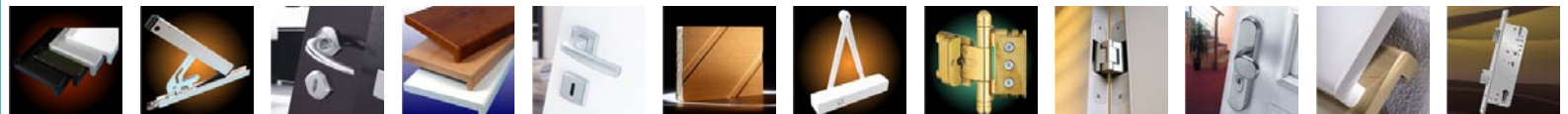









SOUPRAVY PRO PROFILOVÉ DVEŘE

Vyobrazení	Obj. číslo	Čtyřhran		TS	Šroub	Kód barvy	Hliník			Nerez			Mosaz			Plast		
			SST				Barevné provedení			Sklad			Cena brutto v Kč					
Kótovaný náčres <i>Str./ poz. 142/ 1</i>	099KH/3357N/3357N-RF/1313G						LIVERPOOL									36 MM		
	2906623	8/*	-	PZ/92	67-72	M6x80	F1-2	Elox přírodní matný			X			1 267,-				
	3035022	8/*	-	PZ/92	67-72	M6x80	F4	Elox bronz			X			1 457,-				
	2906640	8/*	-	PZ/92	67-72	M6x80	F9	Elox ocel			X			1 457,-				
	2906666	8/*	-	PZ/92	67-72	M6x80	F8707	Tmavohnědá lesklá			X			1 267,-				
	2906703	8/*	-	PZ/92	67-72	M6x80	F9016	Bílá			X			1 267,-				
	<p><i>*) Poznámka: čtyřhran 105mm je pevně nalisovaný ve snížené klice.</i></p> <p><i>Poznámka: montážní sady pro jinou tloušťku dveří - strana 153/ poz.1.</i></p>																	



SOUPRAVY PRO PROFILOVÉ DVEŘE
Hliník
Nerez
Mosaz
Plast

Vyobrazení	Obj. číslo	Čtyřhran			TS	Šroub	Kód barvy	Barevné provedení	Sklad	Cena brutto v Kč
			SST							
Kótovaný náčr. Str. poz. 142/ 2	1313G/3358/3357N-RF						Tt2	LIVERPOOL		36 MM
	2895151	8/145	-	PZ/92	67-72	M6x80	F1-2	Elox přírodní matný		1 917,-
	2895178	8/145	-	PZ/92	67-72	M6x80	F9	Elox ocel		2 204,-
	2895194	8/145	-	PZ/92	67-72	M6x80	F8707	Tmavohnědá lesklá		1 917,-
	2895215	8/145	-	PZ/92	67-72	M6x80	F9016	Barva Bílá		1 917,-
<i>Poznámka: montážní sady pro jinou tloušťku dveří - strana 153/ poz.1.</i>										
Kótovaný náčr. Str. poz. 142/ 3	86G/3358/3357N-RF/1313G						Tt2	LIVERPOOL		36 MM
	2894909	8/110	-	PZ/92	67-72	M6x80	F1-2	Elox přírodní matný		1 917,-
	2894933	8/110	-	PZ/92	67-72	M6x80	F9	Elox ocel		2 204,-
	2895047	8/110	-	PZ/92	67-72	M6x80	F8707	Tmavohnědá lesklá		1 917,-
	2895098	8/110	-	PZ/92	67-72	M6x80	F9016	Barva bílá		1 917,-
<i>Poznámka: montážní sady pro jinou tloušťku dveří - strana 153/ poz.2.</i>										





SOUPRAVY PRO PROFILOVÉ DVEŘE
Hliník
Nerez
Mosaz
Plast

Vyobrazení	Obj. číslo	Čtyřhran			TS	Šroub	Kód barvy	Barevné provedení	Sklad	Cena brutto v Kč
			SST							
Kótovaný náčr. Str./ poz. 142/ 4	1313G/3359ZA/3357N-RF						Tt2	LIVERPOOL		36 MM
	3475087	8/145	-	PZ/92	72-77	M6x80	F1-2	Elox přírodní matný		2 002,-
	3475095	8/145	-	PZ/92	72-77	M6x80	F4	Elox bronz		2 306,-
	3475108	8/145	-	PZ/92	72-77	M6x80	F9	Elox ocel		2 306,-
	2895653	8/145	-	PZ/92	72-77	M6x80	F8707	Tmavohnědá lesklá		2 499,-
	3475116	8/145	-	PZ/92	72-77	M6x80	F9016	Bílá		2 002,-
<i>Poznámka: montážní sady pro jinou tloušťku dveří - strana 153/ poz.1.</i>										
Kótovaný náčr. Str./ poz. 142/ 5	86G/3359ZA/3357N-RF/1313G						Tt2	LIVERPOOL		36 MM
	3475044	8/110	-	PZ/92	72-77	M6x80	F1-2	Elox přírodní matný		2 002,-
	3475052	8/110	-	PZ/92	72-77	M6x80	F4	Elox bronz		2 306,-
	3475061	8/110	-	PZ/92	72-77	M6x80	F9	Elox ocel		2 306,-
	2895493	8/110	-	PZ/92	72-77	M6x80	F8707	Tmavohnědá lesklá		2 499,-
	3475079	8/110	-	PZ/92	72-77	M6x80	F9016	Bílá		2 002,-
<i>Poznámka: montážní sady pro jinou tloušťku dveří - strana 153/ poz.2.</i>										





SOUPRAVY PRO PROFILOVÉ DVEŘE							Hliník	Nerez	Mosaz	Plast
Vyobrazení	Obj. číslo	Čtýřhran		TS	Šroub	Kód barvy	Barevné provedení	Sklad	Cena brutto v Kč	
			SST							
	E1313G/3357N-RF						LIVERPOOL		35 MM	
	3480880	*	-	PZ/92	-	*	F69	Nerez matná 	1 927,-	
<p><i>*) Poznámka: montážní sada není součástí balení.</i></p> <p><i>Poznámka: montážní sady pro jinou tloušťku dveří - strana 153/ poz.1.</i></p>										
	E86G/3357N/3357N-RF/1313G						LIVERPOOL		35 MM	
	3480767	*	-	PZ/92	-	*	F69	Nerez matná 	2 256,-	
<p><i>*) Poznámka: montážní sada není součástí balení.</i></p> <p><i>Poznámka: montážní sady pro jinou tloušťku dveří - strana 153/ poz.2.</i></p>										







SOUPRAVY PRO PROFILOVÉ DVEŘE
Hliník
Nerez
Mosaz
Plast

Vyobrazení	Obj. číslo	Čtyřhran			TS	Šroub	Kód barvy	Barevné provedení	Sklad	Cena brutto v Kč
			SST							
	E1313G/3357N-RF							LIVERPOOL		35 MM
	3395976	8/155	-	PZ/92	72-77	M6x85	F69	Nerez matná		1 956,-
<i>Poznámka: montážní sady pro jinou tloušťku dveří - strana 153/ poz.1.</i>										
	E86G/3357N/3357N-RF/1313G							LIVERPOOL		35 MM
	3395634	8/110	-	PZ/92	72-77	M6x85	F69	Nerez matná		2 285,-
<i>Poznámka: montážní sady pro jinou tloušťku dveří - strana 153/ poz.2.</i>										





SOUPRAVY PRO PROFILOVÉ DVEŘE
Hliník
Nerez
Mosaz
Plast

Vyobrazení	Obj. číslo	Čtyřhran		TS	Šroub	Kód barvy	Barevné provedení	Sklad	Cena brutto v Kč
			SST						
	E099KH/3357N/3357N-RF/1313G						LIVERPOOL		35 MM
	3086129	8/*	-	PZ/92	67-72	M6x80	F69	Nerez matná	X
<p><i>*) Poznámka: čtyřhran 105mm je pevně nalisovaný ve snížené klice.</i></p> <p><i>Poznámka: montážní sady pro jinou tloušťku dveří - strana 153/ poz.1.</i></p>									
	E1313G/3358/3357N-RF						Tt2	LIVERPOOL	35 MM
	3462631	8/155	-	PZ/92	72-77	M6x85	F69	Nerez matná	
<p><i>Poznámka: montážní sady pro jinou tloušťku dveří - strana 153/ poz.1.</i></p>									





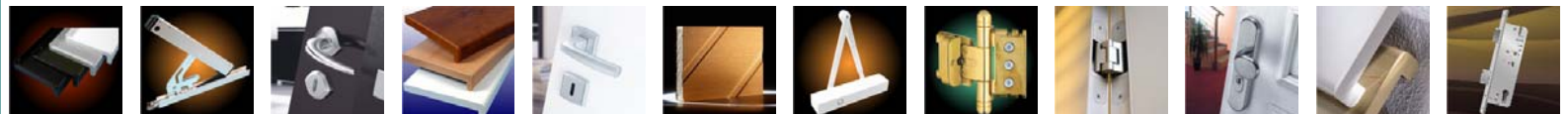

SOUPRAVY PRO PROFILOVÉ DVEŘE
Hliník
Nerez
Mosaz
Plast

Vyobrazení	Obj. číslo	Čtyřhran			TS	Šroub	Kód barvy	Barevné provedení	Sklad	Cena brutto v Kč
			SST							
Kótovaný náčr. Str./ poz. 143/ 4	E86G/3358/3357N-RF/1313G						Tt2	LIVERPOOL		35 MM
	3462770	8/110	-	PZ/92	72-77	M6x85	F69	Nerez matná		4 227,-
<i>Poznámka: montážní sady pro jinou tloušťku dveří - strana 153/ poz.2.</i>										
Kótovaný náčr. Str./ poz. 143/ 5	E099KH/3358/3357N-RF/1313G						Tt2	LIVERPOOL		35 MM
	2899321	8/*	-	PZ/92	67-72	M6x80	F69	Nerez matná		4 890,-
<i>*) Poznámka: čtyřhran 105mm je pevně nalisovaný ve snížené klice.</i>										
<i>Poznámka: montážní sady pro jinou tloušťku dveří - strana 153/ poz.1.</i>										





SOUPRAVY PRO PROFILOVÉ DVEŘE

Vyobrazení	Obj. číslo	Čtyřhran		TS	Šroub	Kód barvy	Barevné provedení	Sklad	Cena brutto v Kč
			SST						
<i>Kótovaný náčrsek Str./ poz. 143/ 6</i>	E1313G/3359ZA/3357N-RF					Tt2	LIVERPOOL		35 MM
	3478333	8/155	-	PZ/92	72-77	M6x85	F69	Nerez matná 	4 730,-
<i>Poznámka: montážní sady pro jinou tloušťku dveří - strana 153/ poz.1.</i>									
<i>Kótovaný náčrsek Str./ poz. 144/ 1</i>	E86G/3359ZA/3357N-RF/1313G					Tt2	LIVERPOOL		35 MM
	3478544	8/110	-	PZ/92	72-77	M6x85	F69	Nerez matná 	4 730,-
<i>Poznámka: montážní sady pro jinou tloušťku dveří - strana 153/ poz.2.</i>									





SOUPRAVY PRO PROFILOVÉ DVEŘE
Hliník
Nerez
Mosaz
Plast

Vyobrazení	Obj. číslo	Čtyřhran			TS	Šroub	Kód barvy	Barevné provedení	Sklad	Cena brutto v Kč
			SST							
	M1313G/3357N-RF							LIVERPOOL		35 MM
	2899638	8/145	-	PZ/92	67-72	M6x80	F71	Mosaz lesklá	X	3 821,-
	2899662	8/145	-	PZ/92	67-72	M6x80	F73	Mosaz brynýrovaná	X	3 821,-
	2888517	8/145	-	PZ/92	67-72	M6x80	F77-R	Mosaz lesklá- Resista [®]	X	4 581,-
<i>Poznámka: montážní sady pro jinou tloušťku dveří - strana 153/ poz.1.</i>										
	M86G/3357N/3357N-RF/1313G							LIVERPOOL		35 MM
	2899566	8/100	-	PZ/92	67-72	M6x80	F71	Mosaz lesklá	X	4 311,-
	2899582	8/100	-	PZ/92	67-72	M6x80	F73	Mosaz brynýrovaná	X	4 311,-
	2888040	8/100	-	PZ/92	67-72	M6x80	F77-R	Mosaz lesklá- Resista [®]	X	5 310,-
<i>Poznámka: montážní sady pro jinou tloušťku dveří - strana 153/ poz.2.</i>										



SOUPRAVY PRO PROFILOVÉ DVEŘE
Hliník
Nerez
Mosaz
Plast

Vyobrazení	Obj. číslo	Čtyřhran		TS	Šroub	Kód barvy	Barevné provedení	Sklad	Cena brutto v Kč	
			SST							
 <p>Resista 10-letá záruka na povrchovou úpravu</p>	M551G/3357N/3357N-RF/1313G						LIVERPOOL		35 MM	
	2895928	8/*	-	PZ/92	67-72	**	F71	Mosaz lesklá	X	4 311,-
	2896082	8/*	-	PZ/92	67-72	**	F73	Mosaz brynýrovaná	X	4 311,-
	2887995	8/*	-	PZ/92	67-72	**	F77-R	Mosaz lesklá- Resista [®]	X	5 310,-
<p>*) Poznámka: čtyřhran 40mm je pevně nalisovaný v klice.</p> <p>***) Poznámka: šroub M6x100mm-2ks a šroub M6x80mm-1ks</p>										
	M1693KH/3357N/3357N-RF/1313G						LIVERPOOL		35 MM	
	2899697	8/*	-	PZ/92	67-72	M6x80	F71	Mosaz lesklá	X	3 821,-
	2899742	8/*	-	PZ/92	67-72	M6x80	F73	Mosaz brynýrovaná	X	3 821,-
	2888728	8/*	-	PZ/92	67-72	M6x80	F77-R	Mosaz lesklá- Resista [®]	X	4 581,-
<p>*) Poznámka: čtyřhran 105mm je pevně nalisovaný ve snížené klice.</p> <p>Poznámka: montážní sady pro jinou tloušťku dveří - strana 153/ poz.1.</p>										







SOUPRAVY PRO PROFILOVÉ DVEŘE
Hliník
Nerez
Mosaz
Plast

Vyobrazení	Obj. číslo	Čtyřhran			TS	Šroub	Kód barvy	Barevné provedení	Sklad	Cena brutto v Kč
			SST							
<p>BEZPEČNOSTNÍ TŘÍDA Tb2 ČSN EN 1627 ČSN EN 1630</p> <p>Resista® 10-letá záruka na povrchovou úpravu</p>	M1313G/3358/3357N-RF							Tt2	LIVERPOOL	35 MM
	2881841	8/145	-	PZ/92	67-72	M6x80	F77-R	Mosaz lesklá- Resista®	X	5 476,-
<i>Poznámka: montážní sady pro jinou tloušťku dveří - strana 153/ poz.1.</i>										
<p>BEZPEČNOSTNÍ TŘÍDA Tb2 ČSN EN 1627 ČSN EN 1630</p> <p>Resista® 10-letá záruka na povrchovou úpravu</p>	M86G/3358/3357N-RF/1313G							Tt2	LIVERPOOL	35 MM
	2879901	8/100	-	PZ/92	67-72	M6x80	F77-R	Mosaz lesklá- Resista®	X	5 476,-
<i>Poznámka: montážní sady pro jinou tloušťku dveří - strana 153/ poz.2.</i>										



SOUPRAVY PRO PROFILOVÉ DVEŘE

							Hliník	Nerez	Mosaz	Plast
Vyobrazení	Obj. číslo	Čtyřhran		TS	Šroub	Kód barvy	Barevné provedení	Sklad	Cena brutto v Kč	
			SST							
 <p>Resista® 10-letá záruka na povrchovou úpravu</p>	M551G/3358/3357N-RF/1313G						Tt2	LIVERPOOL		35 MM
	2879602	8/*	-	PZ/92	67-72	M6x80	F77-R	Mosaz lesklá- Resista®	X	5 476,-
*) Poznámka: čtyřhran 40mm je pevně nalisovaný v klice.										
 <p>Resista® 10-letá záruka na povrchovou úpravu</p>	M1313G/3359ZA/3357N-RF						Tt2	LIVERPOOL		35 MM
	2887944	8/145	-	PZ/92	67-72	M6x80	F77-R	Mosaz lesklá- Resista®	X	6 076,-
Poznámka: montážní sady pro jinou tloušťku dveří - strana 153/ poz.1.										



SOUPRAVY PRO PROFILOVÉ DVEŘE
Hliník
Nerez
Mosaz
Plast

Vyobrazení	Obj. číslo	Čtyřhran		TS	Šroub	Kód barvy	Barevné provedení	Sklad	Cena brutto v Kč
			SST						
<p>Resista® 10-letá záruka na povrchovou úpravu</p>	M86G/3359ZA/3357N-RF/1313G						Tt2	LIVERPOOL	35 MM
	2884997	8/110	-	PZ/92	67-72	M6x80	F77-R	Mosaz lesklá- Resista®	X
<i>Poznámka: montážní sady pro jinou tloušťku dveří - strana 153/ poz.2.</i>									
<p>Resista® 10-letá záruka na povrchovou úpravu</p>	M551G/3359ZA/3357N-RF/1313G						Tt2	LIVERPOOL	35 MM
	2881868	8/*	-	PZ/92	67-72	M6x80	F77-R	Mosaz lesklá- Resista®	X
<i>*) Poznámka: čtyřhran 40mm je pevně nalisovaný v klíče.</i>									





SOUPRAVY PRO PROFILOVÉ DVEŘE



								Hliník	Nerez	Mosaz	Plast
Vyobrazení	Obj. číslo	Čtyřhran		TS	Šroub	Kód barvy	Barevné provedení	Sklad	Cena brutto v Kč		
			SST								
Kótovaný náčr. Str./ poz. 145/ 6	113/2246							LONDON		30 MM	
	2205528	8/150	-	PZ/92	67-72	M6x80	F1	Elox přírodní	X	662,-	
	2205552	8/150	-	PZ/92	67-72	M6x80	F4	Elox bronz	X	762,-	
	2205579	8/150	-	PZ/92	67-72	M6x80	F9	Elox ocel	X	762,-	
	2205595	8/150	-	PZ/92	67-72	M6x80	F8707	Tmavohnědá lesklá	X	662,-	
	2205616	8/150	-	PZ/92	67-72	M6x80	F9016	Bílá	X	662,-	
Kótovaný náčr. Str./ poz. 146/ 1	78G/2246/113							LONDON		30 MM	
	2322046	8/100	-	PZ/92	67-72	M6x80	F1	Elox přírodní	X	893,-	
	2273897	8/100	-	PZ/92	67-72	M6x80	F4	Elox bronz	X	1 028,-	
	2328771	8/100	-	PZ/92	67-72	M6x80	F9	Elox ocel	X	1 028,-	
	2425230	8/100	-	PZ/92	67-72	M6x80	F8707	Tmavohnědá lesklá	X	893,-	
	2273900	8/100	-	PZ/92	67-72	M6x80	F9016	Bílá	X	893,-	



SOUPRAVY PRO PROFILOVÉ DVEŘE							Hliník	Nerez	Mosaz	Plast
Vyobrazení	Obj. číslo	Čtyřhran			TS	Šroub	Kód barvy	Barevné provedení	Sklad	Cena brutto v Kč
			SST							
Kótovaný nákres Str./ poz. 146/ 2	113KH/2246/113						LONDON		30 MM	
	2746181	8/120	-	PZ/92	67-72	M6x80	F1	Elox přírodní	X	718,-
	2746199	8/120	-	PZ/92	67-72	M6x80	F8707	Tmavohnědá lesklá	X	718,-
	2746236	8/120	-	PZ/92	67-72	M6x80	F9016	Bílá	X	718,-





SOUPRAVY PRO PROFILOVÉ DVEŘE

Vyobrazení	Obj. číslo	Čtyřhran		TS	Šroub	Kód barvy	Barevné provedení	Sklad	Cena brutto v Kč	
			SST							
	1500/3357N-RF						LUXEMBOURG		36 MM	
	2004873	8/145	-	PZ/92	72-77	M6x85	F1-2	Elox přírodní matný	✓	1 298,-
	2896867	8/145	-	PZ/92	72-77	M6x85	F4	Elox bronz	✓	1 492,-
	2212795	8/145	-	PZ/92	72-77	M6x85	F9	Elox ocel	✓	1 492,-
	8036006	8/145	-	PZ/92	72-77	M6x85	F8707	Tmavohnědá lesklá	✓	1 298,-
	8002917	8/145	-	PZ/92	72-77	M6x85	F9016	Bílá	✓	1 298,-
	2736767	8/145	-	PZ/92	72-77	M6x85	F4/F9016	Elox bronz/ Bílá	✓	1 492,-
	2725970	8/145	-	PZ/92	72-77	M6x85	F8707/F9016	Tmavohnědá lesklá/ bílá	✓	1 420,-
<i>Poznámka: montážní sady pro jinou tloušťku dveří - strana 153/ poz.1.</i>										
	86G/3357N/3357N-RF/1500						LUXEMBOURG		36 MM	
	2005059	8/100	-	PZ/92	72-77	M6x85	F1-2	Elox přírodní matný	✓	1 649,-
	2461644	8/100	-	PZ/92	72-77	M6x85	F4	Elox bronz	✓	1 897,-
	2896883	8/100	-	PZ/92	72-77	M6x85	F9	Elox ocel	✓	1 897,-
	2005041	8/100	-	PZ/92	72-77	M6x85	F8707	Tmavohnědá lesklá	✓	1 649,-
	2005032	8/100	-	PZ/92	72-77	M6x85	F9016	Bílá	✓	1 649,-
	2736812	8/100	-	PZ/92	72-77	M6x85	F4/F9016	Elox bronz/ Bílá	✓	1 897,-
	2734278	8/100	-	PZ/92	72-77	M6x85	F8707/F9016	Tmavohnědá lesklá/ bílá	✓	1 769,-
<i>Poznámka: montážní sady pro jinou tloušťku dveří - strana 153/ poz.2.</i>										











SOUPRAVY PRO PROFILOVÉ DVEŘE

								Hliník	Nerez	Mosaz	Plast
Vyobrazení	Obj. číslo	Čtyřhran		TS	Šroub	Kód barvy	Barevné provedení	Sklad	Cena brutto v Kč		
			SST								
	513G/3357N/3357N-RF/1500						LUXEMBOURG		36 MM		
	8018756	8/*	-	PZ/92	72-77	**	F1-2	Elox přírodní matný	✓	1 938,-	
	2896875	8/*	-	PZ/92	72-77	**	F4	Elox bronz	✓	2 229,-	
	2212883	8/*	-	PZ/92	72-77	**	F9	Elox ocel	✓	2 229,-	
	8015505	8/*	-	PZ/92	72-77	**	F8707	Tmavohnědá lesklá	✓	1 938,-	
	8015497	8/*	-	PZ/92	72-77	**	F9016	Bílá	✓	1 938,-	
	2624933	8/*	-	PZ/92	67-72	***	F4/F9016	Elox bronz/ Bílá	☎	2 610,-	
	<p>*) Poznámka: čtyřhran 40mm je pevně nalisovaný v klice.</p> <p>**) Poznámka: šroub M6x105mm-2ks a šroub M6x85mm-1ks</p> <p>***) Poznámka: šroub M6x100mm-2ks a šroub M6x80mm-1ks</p>										
	099KH/3357N/3357N-RF/1500						LUXEMBOURG		36 MM		
	8106585	8/*	-	PZ/92	67-72	M6x80	F1-2	Elox přírodní matný	☎	2 035,-	
	1774286	8/*	-	PZ/92	67-72	M6x80	F9	Elox ocel	☎	2 341,-	
	8034076	8/*	-	PZ/92	67-72	M6x80	F8707	Tmavohnědá lesklá	☎	2 035,-	
	8047193	8/*	-	PZ/92	67-72	M6x80	F9016	Bílá	☎	1 759,-	
<p>*) Poznámka: čtyřhran 105mm je pevně nalisovaný ve snížené klice.</p> <p>Poznámka: montážní sady pro jinou tloušťku dveří - strana 153/ poz.1.</p>											



SOUPRAVY PRO PROFILOVÉ DVEŘE

								Hliník	Nerez	Mosaz	Plast
Vyobrazení	Obj. číslo	Čtýřhran			TS	Šroub	Kód barvy	Barevné provedení	Sklad	Cena brutto v Kč	
			SST								
Kótovaný náčrsek Str./ poz. 147/ 1	1500/3358/3357N-RF						Tt2	LUXEMBOURG		36 MM	
	2202466	8/145	-	PZ/92	67-72	M6x80	F1-2	Elox přírodní matný	X	2 259,-	
	2764573	8/145	-	PZ/92	67-72	M6x80	F4	Elox bronz	X	2 598,-	
	2202474	8/145	-	PZ/92	67-72	M6x80	F9	Elox ocel		2 598,-	
	2152577	8/145	-	PZ/92	67-72	M6x80	F8707	Tmavohnědá lesklá	X	2 259,-	
	2152542	8/145	-	PZ/92	67-72	M6x80	F9016	Bílá		2 259,-	
<i>Poznámka: montážní sady pro jinou tloušťku dveří - strana 153/ poz.1.</i>											
Kótovaný náčrsek Str./ poz. 147/ 2	86G/3358/3357N-RF/1500						Tt2	LUXEMBOURG		36 MM	
	2202431	8/100	-	PZ/92	67-72	M6x80	F1-2	Elox přírodní matný	X	2 259,-	
	2763239	8/100	-	PZ/92	67-72	M6x80	F4	Elox bronz	X	2 598,-	
	2202440	8/100	-	PZ/92	67-72	M6x80	F9	Elox ocel		2 598,-	
	2202458	8/100	-	PZ/92	67-72	M6x80	F8707	Tmavohnědá lesklá	X	2 259,-	
	2197880	8/100	-	PZ/92	67-72	M6x80	F9016	Bílá		2 259,-	
<i>Poznámka: montážní sady pro jinou tloušťku dveří - strana 153/ poz.2.</i>											















SOUPRAVY PRO PROFILOVÉ DVEŘE

								Hliník	Nerez	Mosaz	Plast
Vyobrazení	Obj. číslo	Čtyřhran		TS	Šroub	Kód barvy	Barevné provedení	Sklad	Cena brutto v Kč		
			SST								
Kótovaný náčr. Str./ poz. 147/ 3	513G/3358/3357N-RF/1500					Tt2	LUXEMBOURG			36 MM	
	2202327	8/*	-	PZ/92	67-72	M6x80	F1-2	Elox přírodní matný	X	2 259,-	
	2202378	8/*	-	PZ/92	67-72	M6x80	F9	Elox ocel	X	2 598,-	
	2152841	8/*	-	PZ/92	67-72	M6x80	F8707	Tmavohnědá lesklá	X	2 259,-	
	2152745	8/*	-	PZ/92	67-72	M6x80	F9016	Bílá	X	2 259,-	
*) Poznámka: čtyřhran 40mm je pevně nalisovaný v klice.											
Kótovaný náčr. Str./ poz. 147/ 4	1500/3359ZA/3357N-RF					Tt2	LUXEMBOURG			36 MM	
	2896921	8/145	-	PZ/92	72-77	M6x85	F1-2	Elox přírodní matný		2 218,-	
	2896971	8/145	-	PZ/92	72-77	M6x85	F4	Elox bronz		2 550,-	
	2897000	8/145	-	PZ/92	72-77	M6x85	F9	Elox ocel		2 550,-	
	2896980	8/145	-	PZ/92	72-77	M6x85	F8707	Tmavohnědá lesklá		3 013,-	
	2049895	8/145	-	PZ/92	72-77	M6x85	F9016	Bílá		2 218,-	
Poznámka: montážní sady pro jinou tloušťku dveří - strana 153/ poz.1.											



SOUPRAVY PRO PROFILOVÉ DVEŘE

								Hliník	Nerez	Mosaz	Plast
Vyobrazení	Obj. číslo	Čtyřhran		TS	Šroub	Kód barvy	Barevné provedení	Sklad	Cena brutto v Kč		
			SST								
Kótovaný náčr. Str./ poz. 147/ 5	86G/3359ZA/3357N-RF/1500					Tt2	LUXEMBOURG		36 MM		
	2897034	8/110	-	PZ/92	72-77	M6x85	F1-2	Elox přírodní matný		2 218,-	
	2897042	8/110	-	PZ/92	72-77	M6x85	F4	Elox bronz		2 550,-	
	2897077	8/110	-	PZ/92	72-77	M6x85	F9	Elox ocel		2 550,-	
	2897051	8/110	-	PZ/92	72-77	M6x85	F8707	Tmavohnědá lesklá		2 877,-	
	2054774	8/110	-	PZ/92	72-77	M6x85	F9016	Bílá		2 218,-	
<i>Poznámka: montážní sady pro jinou tloušťku dveří - strana 153/ poz.2.</i>											
Kótovaný náčr. Str./ poz. 147/ 6	513G/3359ZA/3357N-RF/1500					Tt2	LUXEMBOURG		36 MM		
	2202167	8/*	-	PZ/92	67-72	M6x80	F1-2	Elox přírodní matný		2 218,-	
	1994650	8/*	-	PZ/92	67-72	M6x80	F4	Elox bronz		2 550,-	
	2202175	8/*	-	PZ/92	67-72	M6x80	F9	Elox ocel		2 550,-	
	2202191	8/*	-	PZ/92	67-72	M6x80	F8707	Tmavohnědá lesklá		3 013,-	
	1994625	8/*	-	PZ/92	67-72	M6x80	F9016	Bílá		2 218,-	
<i>*) Poznámka: čtyřhran 40mm je pevně nalisovaný v klice.</i>											



















SOUPRAVY PRO PROFILOVÉ DVEŘE
Hliník
Nerez
Mosaz
Plast

Vyobrazení	Obj. číslo	Čtyřhran			TS	Šroub	Kód barvy	Barevné provedení	Sklad	Cena brutto v Kč
			SST							
 <i>Kótovaný nákres Str./ poz. 148/ 1</i>	1138/30P/30PS							MARSEILLE		29 MM
	2798028	8/120		PZ	65-75	-	F1	Elox přírodní	X	715,-
 <i>Kótovaný nákres Str./ poz. 148/ 2</i>	E1138Z/30P/30PS							MARSEILLE		29 MM
	3292272	8/120		PZ	65-75	-	F69	Nerez matná	X	1 578,-



SOUPRAVY PRO PROFILOVÉ DVEŘE
Hliník
Nerez
Mosaz
Plast

Vyobrazení	Obj. číslo	Čtyřhran			TS	Šroub	Kód barvy	Barevné provedení	Sklad	Cena brutto v Kč
			SST							
Kótovaný náčrtek Str./ poz. 148/ 3	M112SH/387N							MÜNCHEN		32 MM
 <p>Resista 10-letá záruka na povrchovou úpravu</p>	6820500(L)	8/150	-	PZ/92	58-63	M5x70	F71	Mosaz lesklá		4 020,-
	6820534(L)	8/150	-	PZ/92	58-63	M5x70	F73	Mosaz brynýrovaná		4 020,-
	1896486(L)	8/150	-	PZ/92	58-63	M5x70	F77-R	Mosaz lesklá- Resista [®]		4 521,-
	6820294(R)	8/150	-	PZ/92	58-63	M5x70	F71	Mosaz lesklá		4 020,-
	6820518(R)	8/150	-	PZ/92	58-63	M5x70	F73	Mosaz brynýrovaná		4 020,-
	1896460(R)	8/150	-	PZ/92	58-63	M5x70	F77-R	Mosaz lesklá- Resista [®]		4 521,-
Kótovaný náčrtek Str./ poz. 148/ 4	M52G/387N/112SH							MÜNCHEN		32 MM
	6822209(L)	8/100	-	PZ/92	58-63	M5x70	F71	Mosaz lesklá		6 494,-
	6822217(L)	8/100	-	PZ/92	58-63	M5x70	F73	Mosaz brynýrovaná		6 494,-
	2047152(L)	8/100	-	PZ/92	58-63	M5x70	F77-R	Mosaz lesklá- Resista [®]		6 996,-
	6822142(R)	8/100	-	PZ/92	58-63	M5x70	F71	Mosaz lesklá		6 494,-
	6822225(R)	8/100	-	PZ/92	58-63	M5x70	F73	Mosaz brynýrovaná		6 494,-
	2047144(R)	8/100	-	PZ/92	58-63	M5x70	F77-R	Mosaz lesklá- Resista [®]		6 996,-



SOUPRAVY PRO PROFILOVÉ DVEŘE
Hliník
Nerez
Mosaz
Plast

Vyobrazení	Obj. číslo	Čtyřhran			TS	Šroub	Kód barvy	Barevné provedení	Sklad	Cena brutto v Kč
			SST							
<i>Kótovaný náčrtes</i> Str./ poz. 148/ 5	1810/303N							NEW YORK		24 MM
	3478641	8/115		PZ/92	72-77	M6x85	F1	Elox přírodní		701,-
	3478659	8/115		PZ/92	72-77	M6x85	F4	Elox bronz		735,-
	3478683	8/115		PZ/92	72-77	M6x85	F9	Elox ocel		735,-
	3478675	8/115		PZ/92	72-77	M6x85	F8707	Tmavohnědá lesklá		701,-
	3478704	8/115		PZ/92	72-77	M6x85	F9016	Bílá		701,-
<i>Kótovaný náčrtes</i> Str./ poz. 148/ 6	554/303N/1810							NEW YORK		24 MM
	3278884	8/40		PZ/92	67-72	M6x80	F1	Elox přírodní		1 214,-
	3278892	8/40		PZ/92	67-72	M6x80	F9	Elox ocel		1 397,-
	3278905	8/40		PZ/92	67-72	M6x80	F8707	Tmavohnědá lesklá		1 214,-
	3278913	8/40		PZ/92	67-72	M6x80	F9016	Bílá		1 214,-



SOUPRAVY PRO PROFILOVÉ DVEŘE
Hliník
Nerez
Mosaz
Plast









Vyobrazení	Obj. číslo	Čtyřhran		TS	Šroub	Kód barvy	Barevné provedení	Sklad	Cena brutto v Kč	
			SST							
Kótovaný náčrtek Str./ poz. 149/ 1	099KH/303N/1810					NEW YORK			24 MM	
	3278681	8/105		PZ/92	67-72	M6x80	F1	Elox přírodní	X	973,-
	3388258	8/105		PZ/92	67-72	M6x80	F4	Elox bronz	X	1 120,-
	3278711	8/105		PZ/92	67-72	M6x80	F9	Elox ocel	X	1 120,-
	3278729	8/105		PZ/92	67-72	M6x80	F8707	Tmavohnědá lesklá	X	973,-
	3278737	8/105		PZ/92	67-72	M6x80	F9016	Bílá	X	973,-



SOUPRAVY PRO PROFILOVÉ DVEŘE

								Hliník	Nerez	Mosaz	Plast
Vyobrazení	Obj. číslo	Čtyřhran			TS	Šroub	Kód barvy	Barevné provedení	Sklad	Cena brutto v Kč	
			SST								
Kótovaný náčrtek Str./ poz. 149/ 2	1810/3346							NEW YORK		30 MM	
	3257371	8/140	-	PZ/92	67-72	M6x80	F1	Elox přírodní		560,-	
	3392759	8/140	-	PZ/92	67-72	M6x80	F2	Elox alpaka		560,-	
	3387378	8/140	-	PZ/92	67-72	M6x80	F4	Elox bronz		644,-	
	3257389	8/140	-	PZ/92	67-72	M6x80	F9	Elox ocel		644,-	
	3257397	8/140	-	PZ/92	67-72	M6x80	F8707	Tmavohnědá lesklá		560,-	
	3257400	8/140	-	PZ/92	67-72	M6x80	F9016	Bílá		560,-	
Kótovaný náčrtek Str./ poz. 149/ 2	1810/3346							NEW YORK		30 MM	
	3479408	8/145	-	PZ/92	72-77	M6x85	F1	Elox přírodní	✓	560,-	
	3479416	8/145	-	PZ/92	72-77	M6x85	F4	Elox bronz	✓	644,-	
	3479432	8/145	-	PZ/92	72-77	M6x85	F9	Elox ocel	✓	644,-	
	3479424	8/145	-	PZ/92	72-77	M6x85	F8707	Tmavohnědá lesklá	✓	560,-	
	3479441	8/145	-	PZ/92	72-77	M6x85	F9016	Bílá	✓	560,-	
	3479459	8/145	-	PZ/92	72-77	M6x85	F4/F9016	Elox bronz/ bílá	✓	687,-	







SOUPRAVY PRO PROFILOVÉ DVEŘE								Hliník	Nerez	Mosaz	Plast
Vyobrazení	Obj. číslo	Čtyřhran			TS	Šroub	Kód barvy	Barevné provedení	Sklad	Cena brutto v Kč	
			SST								
Kótovaný náčr. Str./ poz. 149/ 3	76G/3346/1810							NEW YORK		30 MM	
	3257469	8/100	-	PZ/92	67-72	M6x80	F1	Elox přírodní		724,-	
	3387440	8/100	-	PZ/92	67-72	M6x80	F4	Elox bronz		833,-	
	3257477	8/100	-	PZ/92	67-72	M6x80	F9	Elox ocel		833,-	
	3257485	8/100	-	PZ/92	67-72	M6x80	F8707	Tmavohnědá lesklá		724,-	
	3257493	8/100	-	PZ/92	67-72	M6x80	F9016	Bílá		724,-	
Kótovaný náčr. Str./ poz. 149/ 3	76G/3346/1810							NEW YORK		30 MM	
	3479328	8/100	-	PZ/92	72-77	M6x85	F1	Elox přírodní	✓	724,-	
	3479336	8/100	-	PZ/92	72-77	M6x85	F4	Elox bronz	✓	833,-	
	3479361	8/100	-	PZ/92	72-77	M6x85	F9	Elox ocel	✓	833,-	
	3479352	8/100	-	PZ/92	72-77	M6x85	F8707	Tmavohnědá lesklá	✓	724,-	
	3479379	8/100	-	PZ/92	72-77	M6x85	F9016	Bílá	✓	724,-	
	3479387	8/100	-	PZ/92	72-77	M6x85	F4/F9016	Elox bronz/ bílá	✓	878,-	



SOUPRAVY PRO PROFILOVÉ DVEŘE
Hliník
Nerez
Mosaz
Plast

Vyobrazení	Obj. číslo	Čtyřhran			TS	Šroub	Kód barvy	Barevné provedení	Sklad	Cena brutto v Kč
			SST							
<i>Kótovaný nákres Str./ poz. 149/ 4</i>	554/3346/1810						NEW YORK		30 MM	
	3257557	8/40	-	PZ/92	67-72	M6x80	F1	Elox přírodní	X	1 074,-
	3257565	8/40	-	PZ/92	67-72	M6x80	F9	Elox ocel	X	1 235,-
	3257573	8/40	-	PZ/92	67-72	M6x80	F8707	Tmavohnědá lesklá	X	1 074,-
	3257581	8/40	-	PZ/92	67-72	M6x80	F9016	Bílá	X	1 074,-
<i>Kótovaný nákres Str./ poz. 149/ 5</i>	099KH/3346/1810						NEW YORK		30 MM	
	3478801	8/135	-	PZ/92	72-77	M6x85	F1	Elox přírodní		599,-
	3478819	8/135	-	PZ/92	72-77	M6x85	F4	Elox bronz		674,-
	3478835	8/135	-	PZ/92	72-77	M6x85	F9	Elox ocel		674,-
	3478827	8/135	-	PZ/92	72-77	M6x85	F8707	Tmavohnědá lesklá		599,-
	3478843	8/135	-	PZ/92	72-77	M6x85	F9016	Bílá		599,-



SOUPRAVY PRO PROFILOVÉ DVEŘE								Hliník	Nerez	Mosaz	Plast
Vyobrazení	Obj. číslo	Čtýřhran			TS	Šroub	Kód barvy	Barevné provedení	Sklad	Cena brutto v Kč	
			SST								
Kótovaný náčrsek Str./ poz. 149/ 6	1810G/3357N-RF							NEW YORK		36 MM	
	3668524	8	-	PZ/92	-	*	F1-2	Elox přírodní matný	✓	1 141,-	
	3744144	8	-	PZ/92	-	*	F4	Elox bronz	✓	1 309,-	
	3668567	8	-	PZ/92	-	*	F9	Elox ocel	✓	1 309,-	
	3668591	8	-	PZ/92	-	*	F8707	Tmavohnědá lesklá	☎	1 141,-	
	3668639	8	-	PZ/92	-	*	F9016	Bílá	✓	1 141,-	
	3744195	8	-	PZ/92	-	*	F4/F9016	Elox bronz/ bílá	✓	1 309,-	
*) Poznámka: montážní sada není součástí balení.											
Poznámka: montážní sady pro jinou tloušťku dveří - strana 153/ poz.1.											
Kótovaný náčrsek Str./ poz. 150/ 1	86G/3357N/3357N-RF/1810G							NEW YORK		36 MM	
	3668250	8	-	PZ/92	-	*	F1-2	Elox přírodní matný	✓	1 492,-	
	3744208	8	-	PZ/92	-	*	F4	Elox bronz	✓	1 676,-	
	3668276	8	-	PZ/92	-	*	F9	Elox ocel	✓	1 676,-	
	3477963	8	-	PZ/92	-	*	F8707	Tmavohnědá lesklá	☎	1 492,-	
	3668348	8	-	PZ/92	-	*	F9016	Bílá	✓	1 492,-	
	3744267	8	-	PZ/92	-	*	F4/F9016	Elox bronz/ bílá	✓	1 676,-	
*) Poznámka: montážní sada není součástí balení.											
Poznámka: montážní sady pro jinou tloušťku dveří - strana 153/ poz.2.											







SOUPRAVY PRO PROFILOVÉ DVEŘE
Hliník
Nerez
Mosaz
Plast

Vyobrazení	Obj. číslo	Čtyřhran		TS	Šroub	Kód barvy	Barevné provedení	Sklad	Cena brutto v Kč	
			SST							
<i>Kótovaný nákres Str./ poz. 150/ 2</i>	538G/3357N/3357N-RF/1810G						NEW YORK		36 MM	
	3476901	8/*	-	PZ/92	67-72	**	F1-2	Elox přírodní matný	X	2 259,-
	3476936	8/*	-	PZ/92	67-72	**	F9	Elox ocel	X	2 597,-
	3477015	8/*	-	PZ/92	67-72	**	F8707	Tmavohnědá lesklá	X	2 259,-
	3477031	8/*	-	PZ/92	67-72	**	F9016	Bílá	X	2 259,-
<p><i>*) Poznámka: čtyřhran 40mm je pevně nalisovaný v klice.</i></p> <p><i>***) Poznámka: šroub M6x100mm-2ks a šroub M6x80mm-1ks</i></p>										
<i>Kótovaný nákres Str./ poz. 150/ 3</i>	099KH/3357N/3357N-RF/1810G						NEW YORK		36 MM	
	3478122	8/*	-	PZ/92	67-72	M6x80	F1-2	Elox přírodní matný	X	1 646,-
	3478149	8/*	-	PZ/92	67-72	M6x80	F9	Elox ocel	X	1 893,-
	3478165	8/*	-	PZ/92	67-72	M6x80	F8707	Tmavohnědá lesklá	X	1 646,-
	3478181	8/*	-	PZ/92	67-72	M6x80	F9016	Bílá	X	1 646,-
<p><i>*) Poznámka: čtyřhran 105mm je pevně nalisovaný ve snížené klice.</i></p> <p><i>Poznámka: montážní sady pro jinou tloušťku dveří - strana 153/ poz.1.</i></p>										



SOUPRAVY PRO PROFILOVÉ DVEŘE

								Hliník	Nerez	Mosaz	Plast
Vyobrazení	Obj. číslo	Čtýřhran			TS	Šroub	Kód barvy	Barevné provedení	Sklad	Cena brutto v Kč	
			SST								
Kótovaný náčr. Str./ poz. 150/ 4	1810G/3358/3357N-RF						Tt2	NEW YORK		36 MM	
	3480337	8/145	-	PZ/92	67-72	M6x80	F1-2	Elox přírodní matný	X	1 845,-	
	3480476	8/145	-	PZ/92	67-72	M6x80	F9	Elox ocel	X	2 122,-	
	3480572	8/145	-	PZ/92	67-72	M6x80	F8707	Tmavohnědá lesklá	X	1 845,-	
	3480636	8/145	-	PZ/92	67-72	M6x80	F9016	Bílá	X	1 845,-	
<i>Poznámka: montážní sady pro jinou tloušťku dveří - strana 153/ poz.1.</i>											
Kótovaný náčr. Str./ poz. 150/ 5	86G/3358/3357N-RF/1810G						Tt2	NEW YORK		36 MM	
	3479395	8/100	-	PZ/92	67-72	M6x80	F1-2	Elox přírodní matný	X	1 845,-	
	3479993	8/100	-	PZ/92	67-72	M6x80	F9	Elox ocel	X	2 122,-	
	3480011	8/100	-	PZ/92	67-72	M6x80	F8707	Tmavohnědá lesklá	X	1 845,-	
	3480038	8/100	-	PZ/92	67-72	M6x80	F9016	Bílá	X	1 845,-	
<i>Poznámka: montážní sady pro jinou tloušťku dveří - strana 153/ poz.2.</i>											









SOUPRAVY PRO PROFILOVÉ DVEŘE
Hliník
Nerez
Mosaz
Plast

Vyobrazení	Obj. číslo	Čtyřhran			TS	Šroub	Kód barvy	Barevné provedení	Sklad	Cena brutto v Kč
			SST							
Kótovaný nákres Str./ poz. 150/ 6	1810G/3359ZA/3357N-RF						Tt2	NEW YORK		36 MM
	3477939	8/145	-	PZ/92	67-72	M6x80	F1-2	Elox přírodní matný		2 040,-
	3477955	8/145	-	PZ/92	67-72	M6x80	F9	Elox ocel		2 348,-
	3477998	8/145	-	PZ/92	67-72	M6x80	F8707	Tmavohnědá lesklá		2 405,-
	3478894	8/145	-	PZ/92	67-72	M6x80	F9016	Bílá		2 040,-
<i>Poznámka: montážní sady pro jinou tloušťku dveří - strana 153/ poz.1.</i>										
Kótovaný nákres Str./ poz. 151/ 1	86G/3359ZA/3357N-RF/1810G						Tt2	NEW YORK		36 MM
	3477445	8/110	-	PZ/92	67-72	M6x80	F1-2	Elox přírodní matný		2 040,-
	3477710	8/110	-	PZ/92	67-72	M6x80	F9	Elox ocel		2 348,-
	3477808	8/110	-	PZ/92	67-72	M6x80	F8707	Tmavohnědá lesklá		2 405,-
	3477912	8/110	-	PZ/92	67-72	M6x80	F9016	Bílá		2 040,-
<i>Poznámka: montážní sady pro jinou tloušťku dveří - strana 153/ poz.2.</i>										



SOUPRAVY PRO PROFILOVÉ DVEŘE
Hliník
Nerez
Mosaz
Plast















Vyobrazení	Obj. číslo	Čtýřhran			TS	Šroub	Kód barvy	Barevné provedení	Sklad	Cena brutto v Kč
			SST							
<i>Kótovaný náčrsek</i> Str./ poz. 151/ 2	E138GF/3358/3357N-RF						Tt2	PARIS		35 MM
	2203944	8/145	-	PZ/92	67-72	M6x80	F69	Nerez matná		4 581,-
<i>Poznámka: montážní sady pro jinou tloušťku dveří - strana 153/ poz.1.</i>										
<i>Kótovaný náčrsek</i> Str./ poz. 151/ 3	E86G/3358/3357N-RF/138GF						Tt2	PARIS		35 MM
	2203936	8/110	-	PZ/92	67-72	M6x80	F69	Nerez matná		4 581,-
<i>Poznámka: montážní sady pro jinou tloušťku dveří - strana 153/ poz.2.</i>										



SOUPRAVY PRO PROFILOVÉ DVEŘE
Hliník
Nerez
Mosaz
Plast



Vyobrazení	Obj. číslo	Čtyřhran			TS	Šroub	Kód barvy	Barevné provedení	Sklad	Cena brutto v Kč
			SST							
<i>Kótovaný náčrsek Str./ poz. 151/ 4</i>	E138GF/3359ZA/3357N-RF						Tt2	PARIS		35 MM
	2203910	8/155	-	PZ/92	67-72	M6x80	F69	Nerez matná		5 239,-
<i>Poznámka: montážní sady pro jinou tloušťku dveří - strana 153/ poz.1.</i>										
<i>Kótovaný náčrsek Str./ poz. 151/ 5</i>	E86G/3359ZA/3357N-RF/138GF						Tt2	PARIS		35 MM
	2203901	8/110	-	PZ/92	67-72	M6x80	F69	Nerez matná		5 239,-
<i>Poznámka: montážní sady pro jinou tloušťku dveří - strana 153/ poz.2.</i>										



















SOUPRAVY PRO PROFILOVÉ DVEŘE								Hliník	Nerez	Mosaz	Plast
Vyobrazení	Obj. číslo	Čtyřhran			TS	Šroub	Kód barvy	Barevné provedení	Sklad	Cena brutto v Kč	
			SST								
<i>Kótovaný náčrtek Str./ poz. 151/ 6</i>	1710RH/303N							TOKYO		24 MM	
	1908070	8/100	-	PZ/92	68-72	M6x80	F1	Elox přírodní		787,-	
	2551210	8/100	-	PZ/92	68-72	M6x80	F4	Elox bronz		827,-	
	1741353	8/100	-	PZ/92	68-72	M6x80	F9	Elox ocel		827,-	
	1908109	8/100	-	PZ/92	68-72	M6x80	F8707	Tmavohnědá lesklá		787,-	
	1741302	8/100	-	PZ/92	68-72	M6x80	F9016	Bílá		787,-	
<i>Kótovaný náčrtek Str./ poz. 152/ 1</i>	554/303N/1710RH							TOKYO		24 MM	
	2203565	8/90	-	PZ/92	68-72	M6x80	F1	Elox přírodní		1 304,-	
	1754015	8/90	-	PZ/92	57-62	M6x80	F4	Elox bronz		1 500,-	
	1741396	8/90	-	PZ/92	68-72	M6x80	F9	Elox ocel		1 500,-	
	2203573	8/90	-	PZ/92	68-72	M6x80	F8707	Tmavohnědá lesklá		1 304,-	
	1741425	8/90	-	PZ/92	68-72	M6x80	F9016	Bílá		1 304,-	



SOUPRAVY PRO PROFILOVÉ DVEŘE



								Hliník	Nerez	Mosaz	Plast
Vyobrazení	Obj. číslo	Čtyřhran		TS	Šroub	Kód barvy	Barevné provedení	Sklad	Cena brutto v Kč		
			SST								
	099KH/303N/1710RH						TOKYO	24 MM			
	2203581	8/105	-	PZ/92	67-72	M6x80	F1	Elox přírodní	X	1 010,-	
	1741572	8/105	-	PZ/92	67-72	M6x80	F9	Elox ocel	X	1 161,-	
	2153351	8/105	-	PZ/92	67-72	M6x80	F8707	Tmavohnědá lesklá	X	1 010,-	
	1741556	8/105	-	PZ/92	67-72	M6x80	F9016	Bílá	X	1 010,-	
	1710RH/3346						TOKYO	30 MM			
	2137570	8/135	-	PZ/92	67-72	M6x80	F1	Elox přírodní	✓	564,-	
	2089168	8/135	-	PZ/92	67-72	M6x80	F2	Elox alpaka	X	664,-	
	2085773	8/135	-	PZ/92	67-72	M6x80	F4	Elox bronz	✓	651,-	
	2137713	8/135	-	PZ/92	67-72	M6x80	F9	Elox ocel	✓	651,-	
	2137748	8/135	-	PZ/92	67-72	M6x80	F8707	Tmavohnědá lesklá	✓	564,-	
	2085765	8/135	-	PZ/92	67-72	M6x80	F9016	Bílá	✓	564,-	
	2648775	8/135	-	PZ/92	67-72	M6x80	F4/F9016	Elox bronz/ bílá	✓	636,-	



SOUPRAVY PRO PROFILOVÉ DVEŘE								Hliník	Nerez	Mosaz	Plast
Vyobrazení	Obj. číslo	Čtyřhran			TS	Šroub	Kód barvy	Barevné provedení	Sklad	Cena brutto v Kč	
			SST								
Kótovaný náčrtek Str./ poz. 152/ 4	76G/3346/1710RH							TOKYO		30 MM	
	2137684	8/100	-	PZ/92	67-72	M6x80	F1	Elox přírodní		733,-	
	2089192	8/100	-	PZ/92	67-72	M6x80	F2	Elox alpaka		861,-	
	2137721	8/100	-	PZ/92	67-72	M6x80	F4	Elox bronz		842,-	
	2137772	8/100	-	PZ/92	67-72	M6x80	F9	Elox ocel		842,-	
	2137799	8/100	-	PZ/92	67-72	M6x80	F8707	Tmavohnědá lesklá		733,-	
	2089205	8/100	-	PZ/92	67-72	M6x80	F9016	Bílá		733,-	
	2648741	8/100	-	PZ/92	67-72	M6x80	F4/F9016	Elox bronz/ Bílá		891,-	
Kótovaný náčrtek Str./ poz. 152/ 5	099KH/3346/1710RH							TOKYO		30 MM	
	2183517	8/125	-	PZ/92	67-72	M6x80	F1	Elox přírodní		711,-	
	2302070	8/125	-	PZ/92	67-72	M6x80	F4	Elox bronz		818,-	
	2183525	8/125	-	PZ/92	67-72	M6x80	F9	Elox ocel		818,-	
	2183509	8/125	-	PZ/92	67-72	M6x80	F8707	Tmavohnědá lesklá		711,-	
	2183496	8/125	-	PZ/92	67-72	M6x80	F9016	Bílá		711,-	



SOUPRAVY PRO PROFILOVÉ DVEŘE

								Hliník	Nerez	Mosaz	Plast
Vyobrazení	Obj. číslo	Čtyřhran		TS	Šroub	Kód barvy	Barevné provedení	Sklad	Cena brutto v Kč		
			SST								
	1710RH/3346						TOKYO		30 MM		
	3031312	8/135	-	PZ/90	67-72	M6x80	F1	Elox přírodní		574,-	
	3031339	8/135	-	PZ/90	67-72	M6x80	F4	Elox bronz		661,-	
	76G/3346/1710RH						TOKYO		30 MM		
	3031398	8/100	-	PZ/90	67-72	M6x80	F1	Elox přírodní		744,-	
	3031401	8/100	-	PZ/90	67-72	M6x80	F4	Elox bronz		856,-	



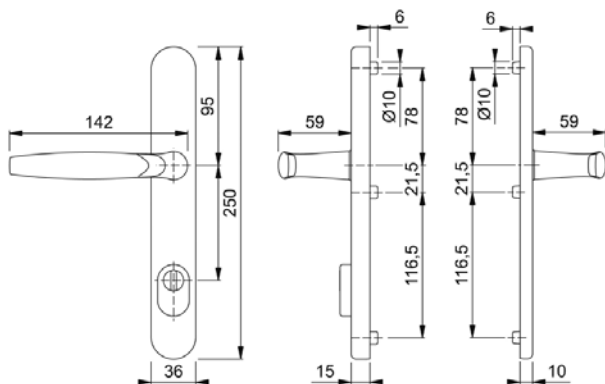

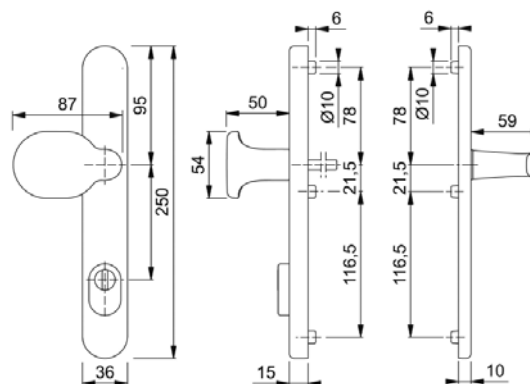
SOUPRAVY PRO PROFILOVÉ DVEŘE - NÁKRESY
Hliník
Nerez
Mosaz
Plast

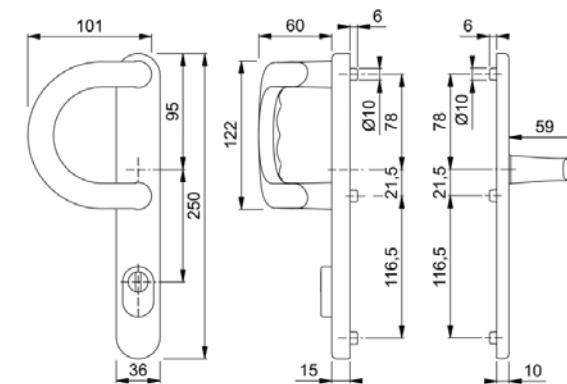
ATLANTA
 1530/3359ZA/3357N-RF

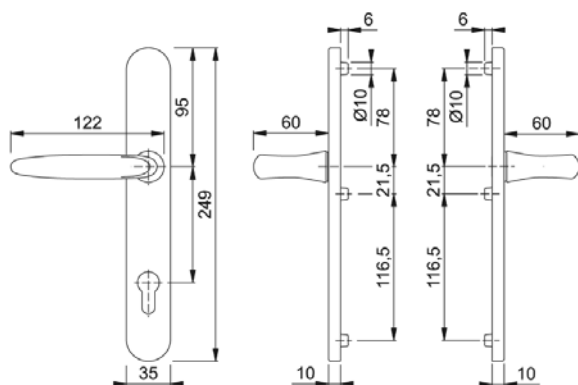
(139/ 1)

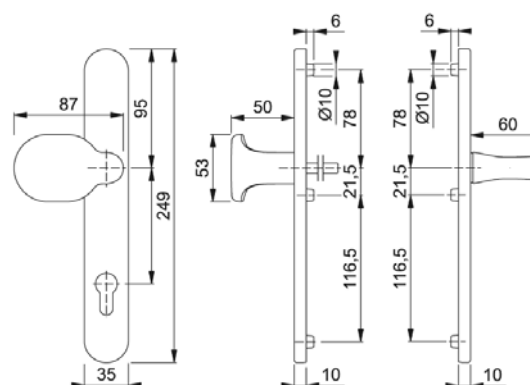
ATLANTA
 86G/3359ZA/3357N-RF/1530

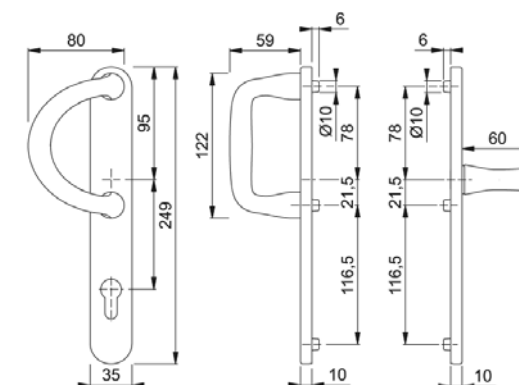
(139/ 2)

ATLANTA
 513G/3359ZA/3357N-RF/1530

(139/ 3)

ATLANTA
 M1530/3357N-RF

(139/ 4)

ATLANTA
 M86G/3357N/3357N-RF/1530

(139/ 5)

ATLANTA
 M551G/3357N/3357N-RF/1530

(139/ 6)



R.S.P. s.r.o.

SOUPRAVY PRO PROFILOVÉ DVEŘE - NÁKRESY

Hliník Nerez Mosaz Plast

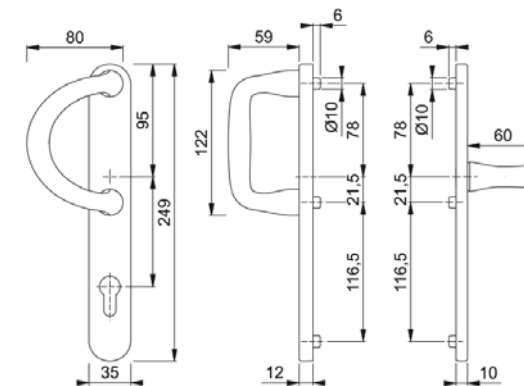
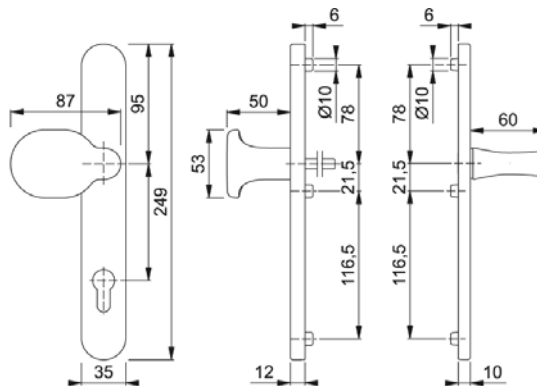
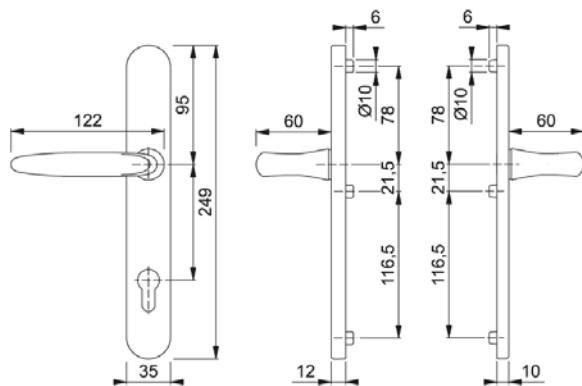

ATLANTA (140/ 1)
M1530/3358/3357N-RF

ATLANTA (140/ 2)
M86G/3358/3357N-RF/1530

ATLANTA (140/ 3)
M551G/3358/3357N-RF/1530

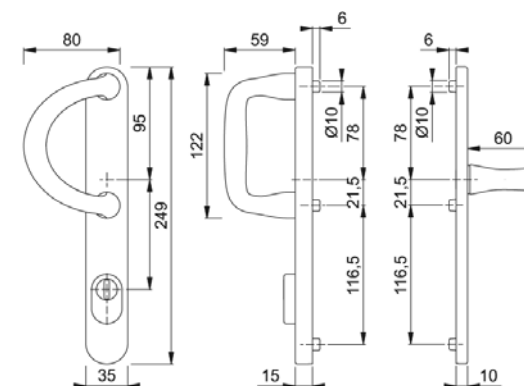
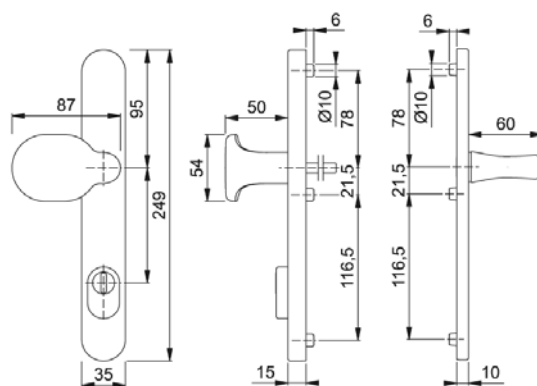
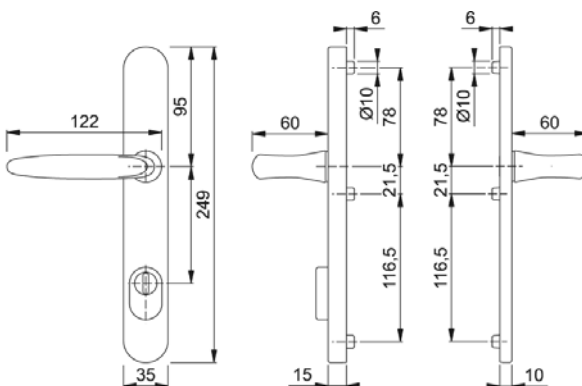

ATLANTA (140/ 4)
M1530/3359ZA/3357N-RF/1530

ATLANTA (140/ 5)
M86G/3359ZA/3357N-RF/1530

ATLANTA (140/ 6)
M551G/3359ZA/3357N-RF/1530

© R.S.P. s.r.o. Týn nad Vltavou

Verze: HOP-SP-06.14

Platnost od: 15.03.2014

Tisk: 01.03.2014

Technické změny vyhrazeny!

140



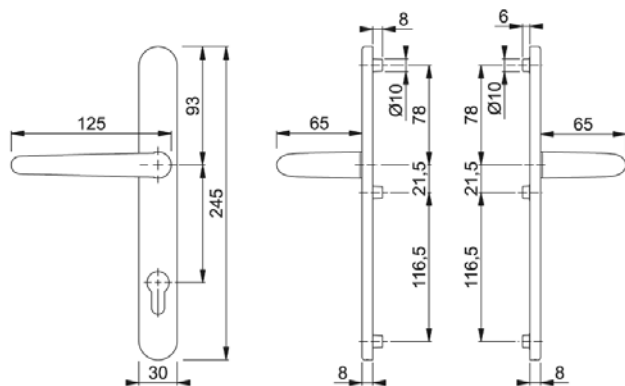

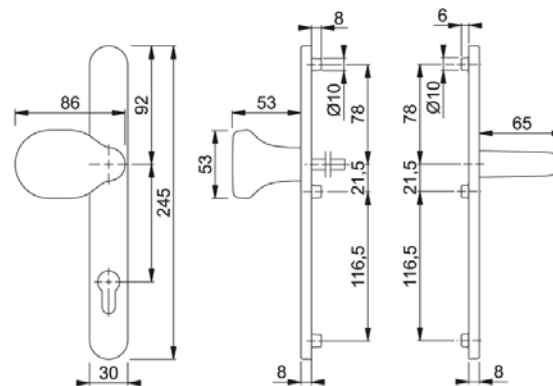
SOUPRAVY PRO PROFILOVÉ DVEŘE - NÁKRESY
Hliník
Nerez
Mosaz
Plast

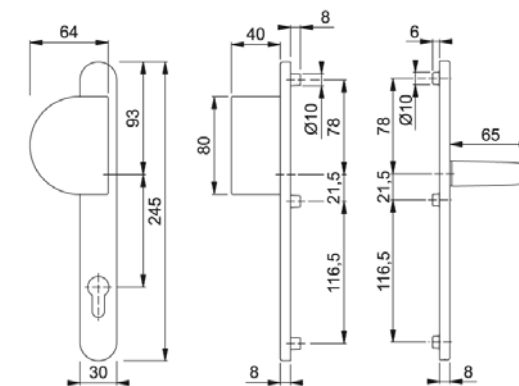
DENVER
E1310Z/3346

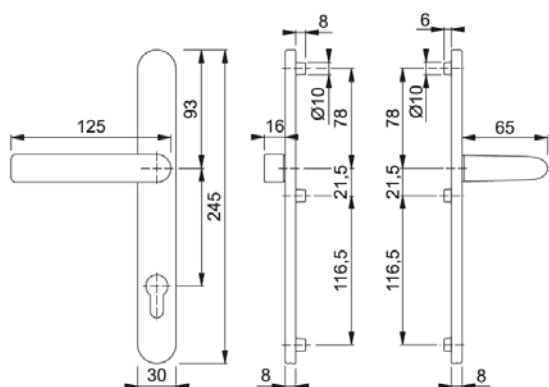
(141/ 1)

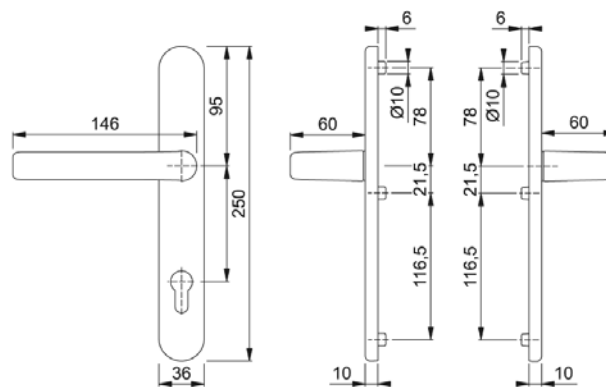
DENVER
E86G/3346/1310Z

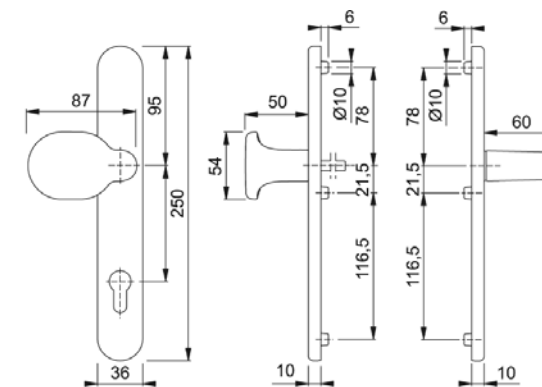
(141/ 2)

DENVER
E554/3346/1310Z

(141/ 3)

DENVER
E099KH/3346/1310Z

(141/ 4)

LIVERPOOL
1313G/3357N-RF

(141/ 5)

LIVERPOOL
86G/3357N/3357N-RF/1313G

(141/ 6)



R.S.P. s.r.o.

SOUPRAVY PRO PROFILOVÉ DVEŘE - NÁKRESY

Hliník

Nerez

Mosaz

Plast

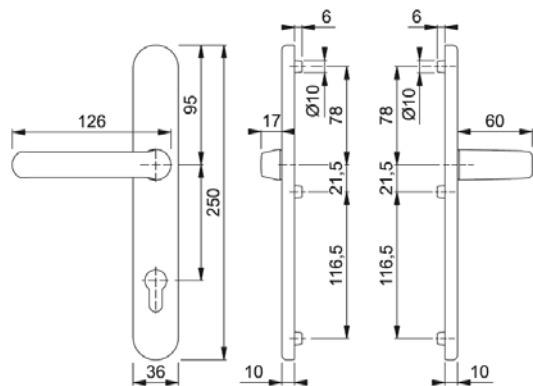

LIVERPOOL

(142/ 1)

099KH/3357N/3357N-RF/1313G

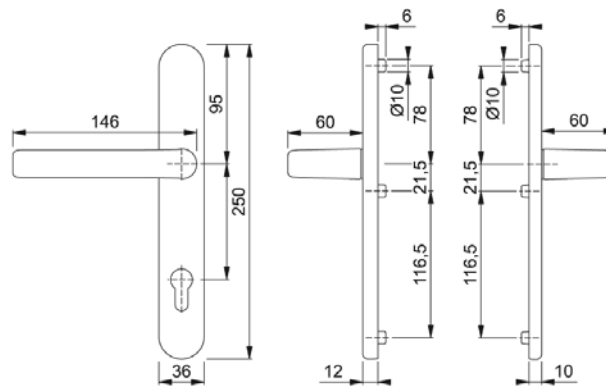

LIVERPOOL

(142/ 2)

1313G/3358/3357N-RF

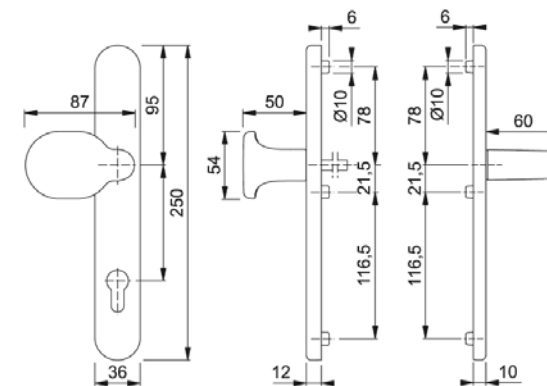

LIVERPOOL

(142/ 3)

86G/3358/3357N-RF/1313G

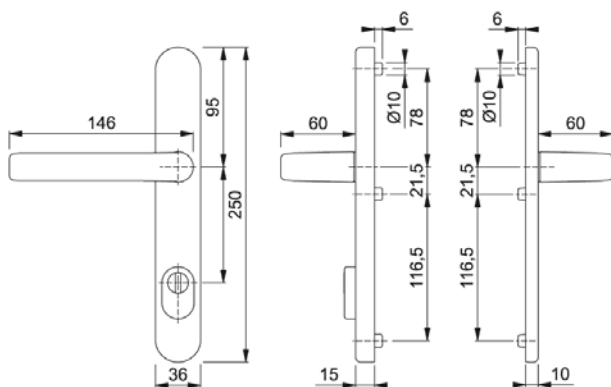

LIVERPOOL

(142/ 4)

1313G/3359ZA/3357N-RF

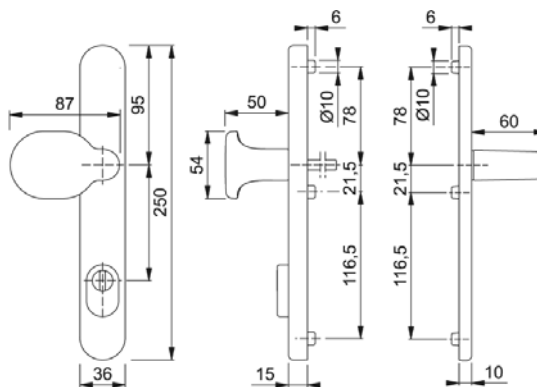

LIVERPOOL

(142/ 5)

86G/3359ZA/3357N-RF/1313G

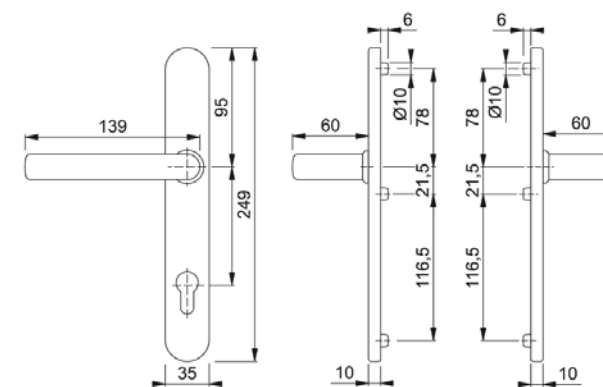

LIVERPOOL

(142/ 6)

E1313G/3357N-RF

© R.S.P. s.r.o. Týn nad Vltavou

Verze: HOP-SP-06.14

Platnost od: 15.03.2014

Tisk: 01.03.2014

Technické změny vyhrazeny!

142





SOUPRAVY PRO PROFILOVÉ DVEŘE - NÁKRESY

Hliník

Nerez

Mosaz

Plast

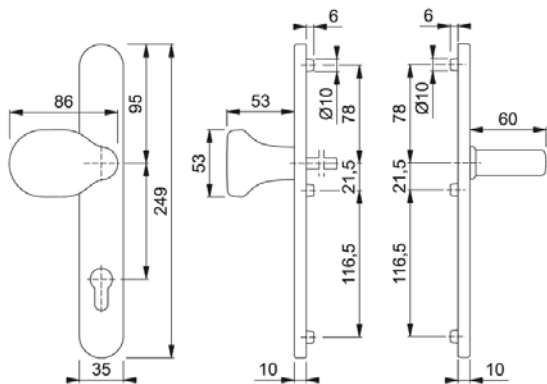

LIVERPOOL
E86G/3357N/3357N-RF/1313G

(143/ 1)

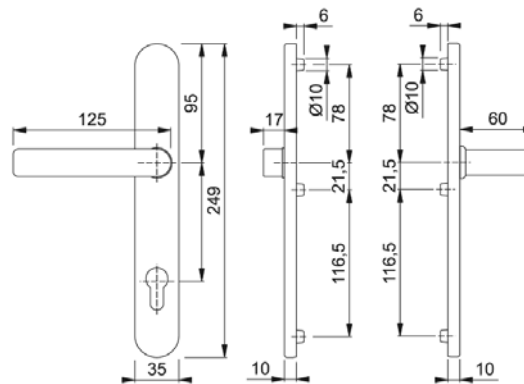

LIVERPOOL
E099KH/3357N/3357N-RF/1313G

(143/ 2)

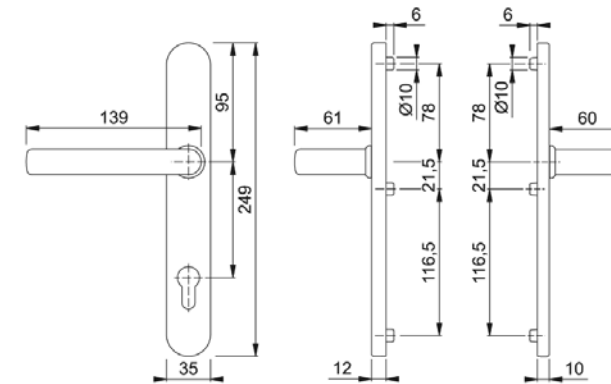

LIVERPOOL
E1313G/3358/3357N-RF

(143/ 3)

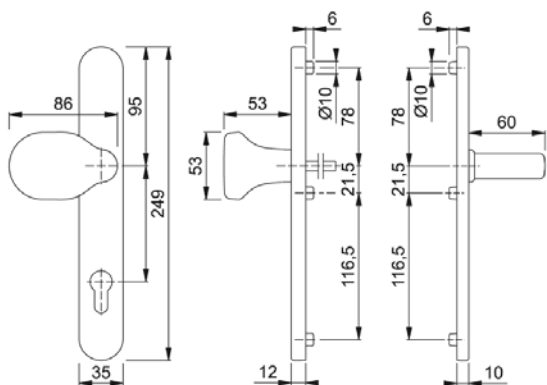

LIVERPOOL
E86G/3358/3357N-RF/1313G

(143/ 4)

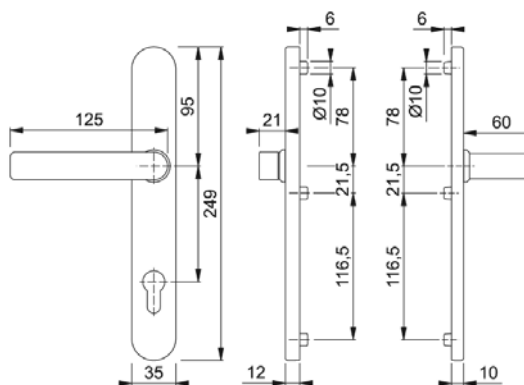

LIVERPOOL
E099KH/3358/3357N-RF/1313G

(143/ 5)

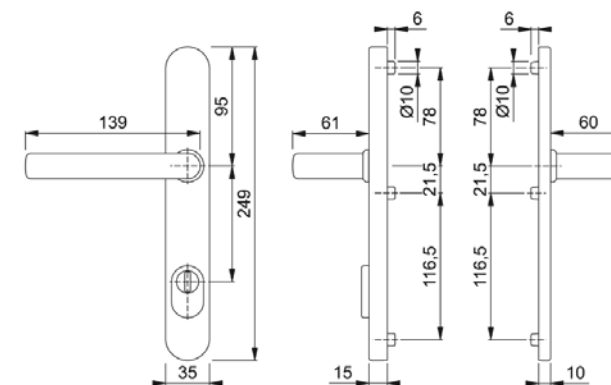

LIVERPOOL
E1313G/3359ZA/3357N-RF

(143/ 6)





R.S.P. s.r.o.

SOUPRAVY PRO PROFILOVÉ DVEŘE - NÁKRESY

Hliník

Nerez

Mosaz

Plast

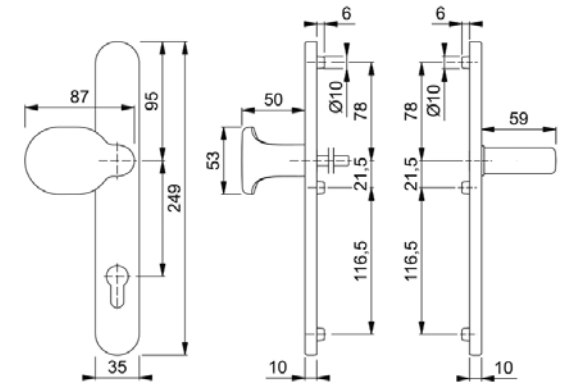
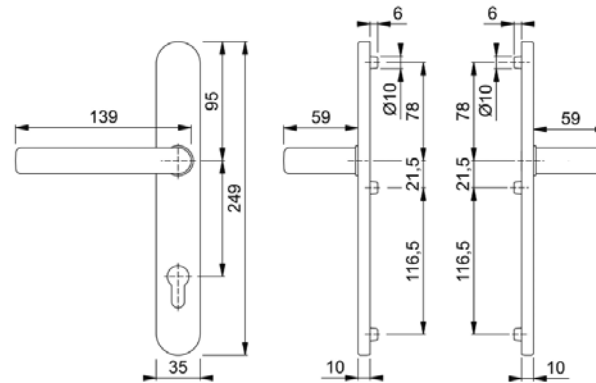
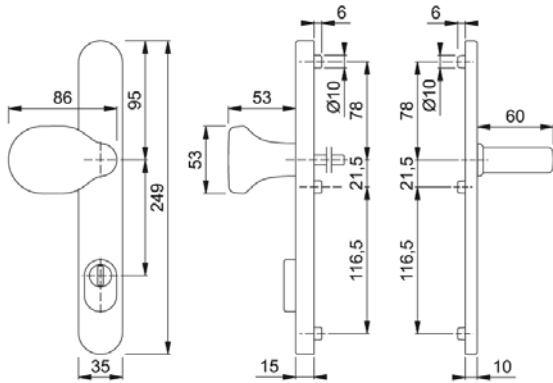

LIVERPOOL (144/ 1)
E86G/3359ZA/3357N-RF/1313G

LIVERPOOL (144/ 2)
M1313G/3357N-RF

LIVERPOOL (144/ 3)
M86G/3357N/3357N-RF/1313G

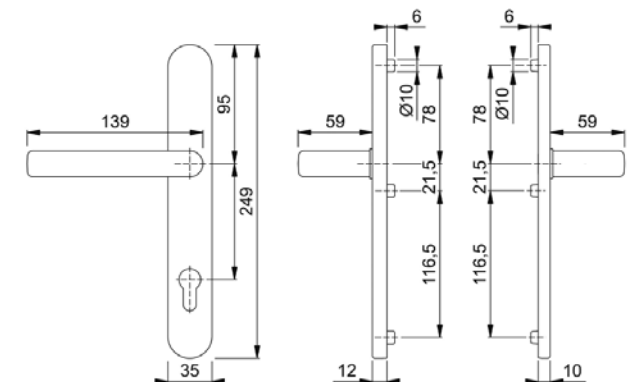
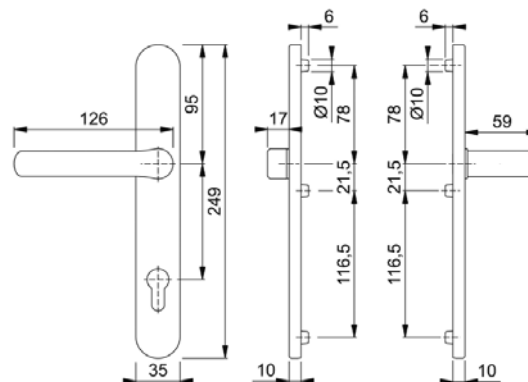
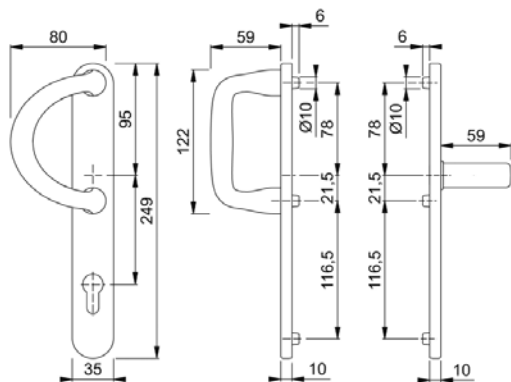

LIVERPOOL (144/ 4)
M551G/3357N/3357N-RF/1313G

LIVERPOOL (144/ 5)
M1693KH/3357N/3357N-RF/1313G

LIVERPOOL (144/ 6)
M1313G/3358/3357N-RF

© R.S.P. s.r.o. Týn nad Vltavou

Verze: HOP-SP-06.14

Platnost od: 15.03.2014

Tisk: 01.03.2014

Technické změny vyhrazeny!

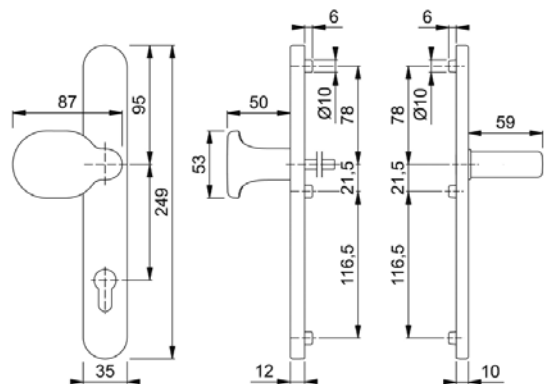
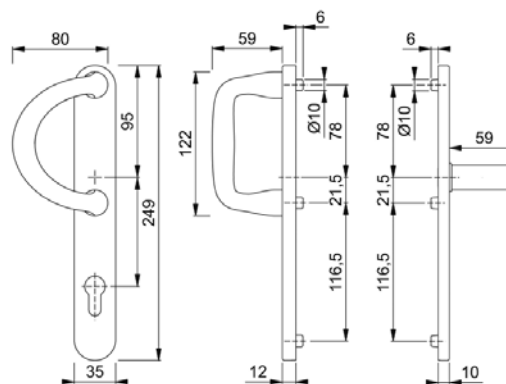
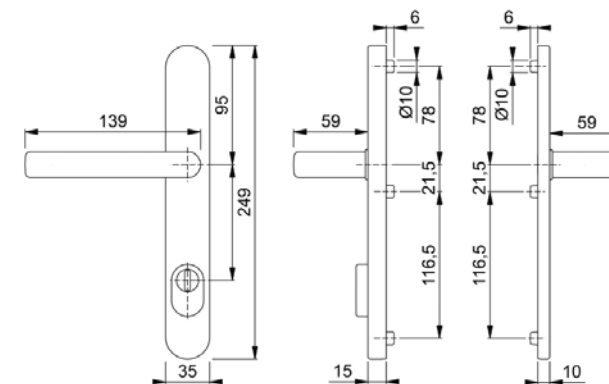
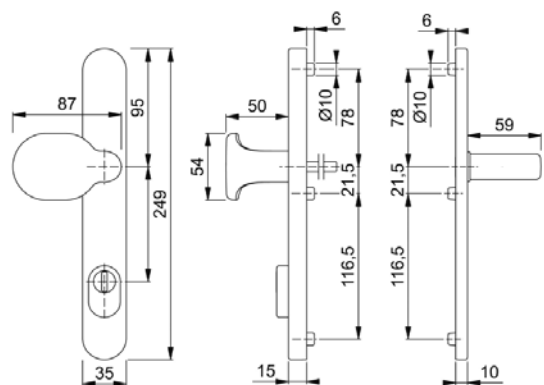
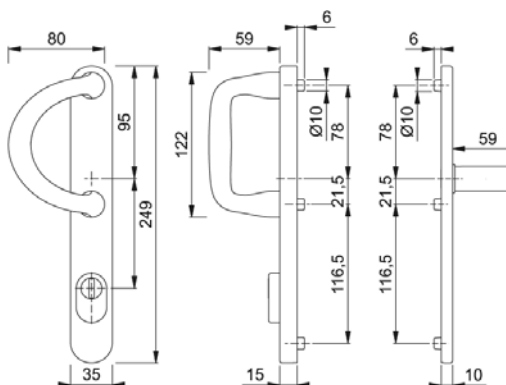
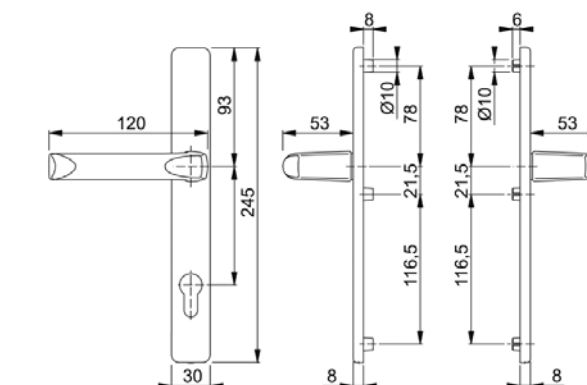

SOUPRAVY PRO PROFILOVÉ DVEŘE - NÁKRESY
Hliník
Nerez
Mosaz
Plast

LIVERPOOL (145/ 1)
 M86G/3358/3357N-RF/1313G

LIVERPOOL (145/ 2)
 M551G/3358/3357N-RF/1313G

LIVERPOOL (145/ 3)
 M1313G/3359ZA/3357N-RF

LIVERPOOL (145/ 4)
 M86G/3359ZA/3357N-RF/1313G

LIVERPOOL (145/ 5)
 M551G/3359ZA/3357N-RF/1313G

LONDON (145/ 6)
 113/2246



R.S.P. s.r.o.

SOUPRAVY PRO PROFILOVÉ DVEŘE - NÁKRESY

Hliník

Nerez

Mosaz

Plast

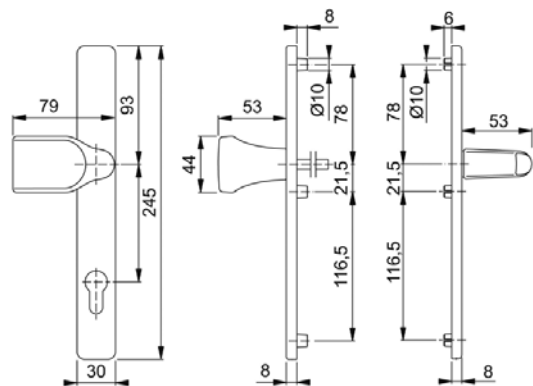

LONDON (146/ 1)
78G/2246/113

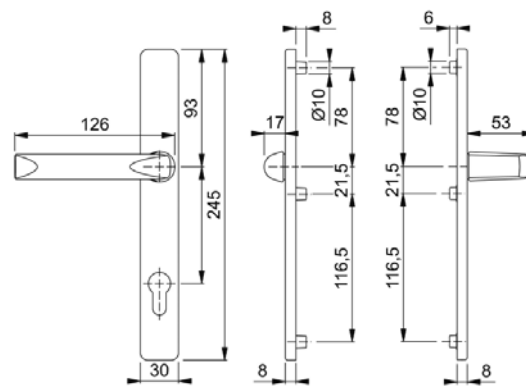

LONDON (146/ 2)
113KH/2246/113

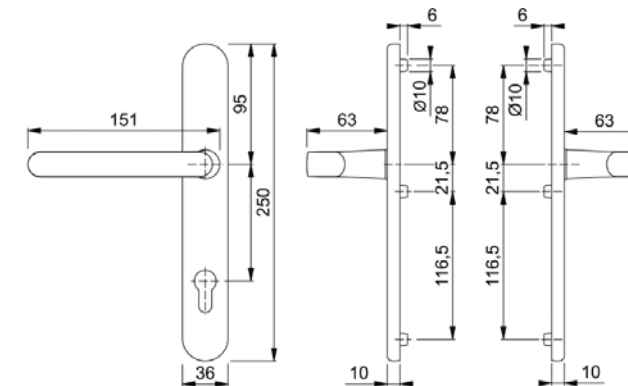

LUXEMBOURG (146/ 3)
1500/3357N-RF

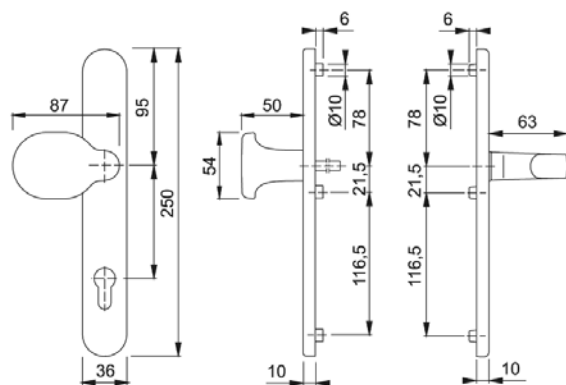

LUXEMBOURG (146/ 4)
86G/3357N/3357N-RF/1500

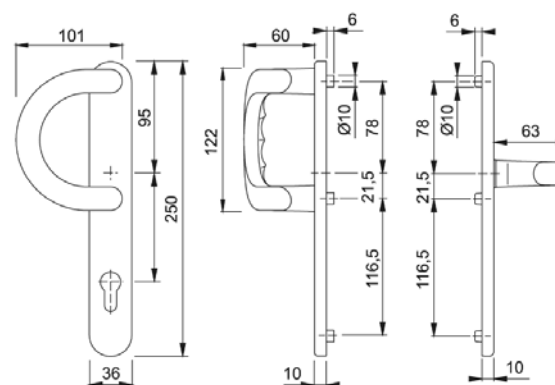

LUXEMBOURG (146/ 5)
513G/3357N/3357N-RF/1500

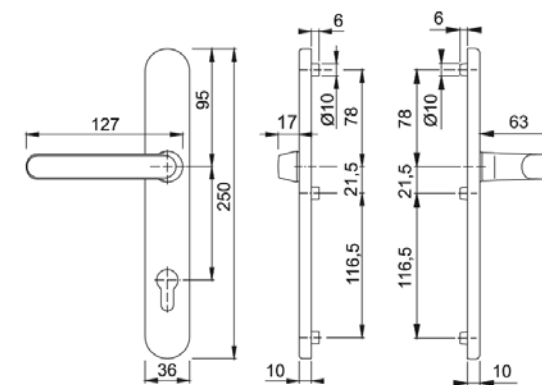

LUXEMBOURG (146/ 6)
099KH/3357N/3357N-RF/1500

© R.S.P. s.r.o. Týn nad Vltavou

Verze: HOP-SP-06.14

Platnost od: 15.03.2014

Tisk: 01.03.2014

Technické změny vyhrazeny!

146



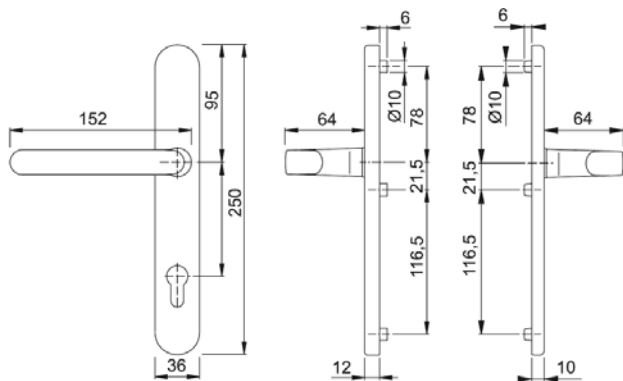

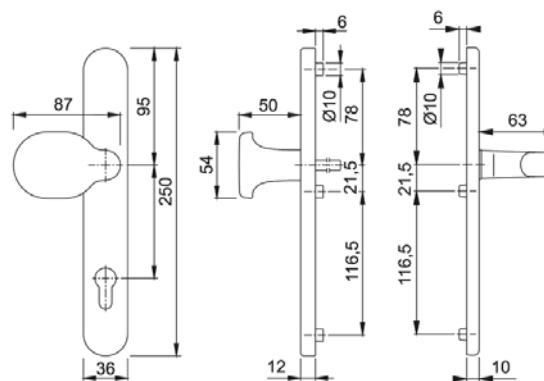
SOUPRAVY PRO PROFILOVÉ DVEŘE - NÁKRESY
Hliník
Nerez
Mosaz
Plast

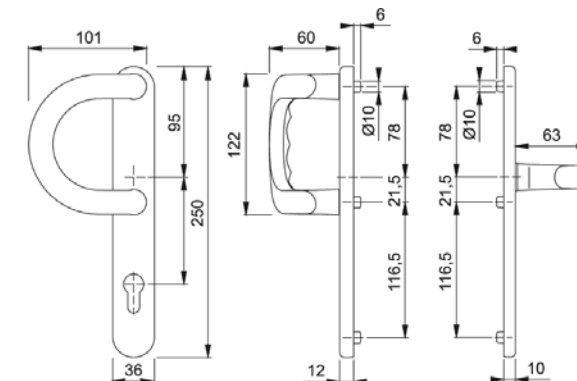
LUXEMBOURG
1500/3358/3357N-RF

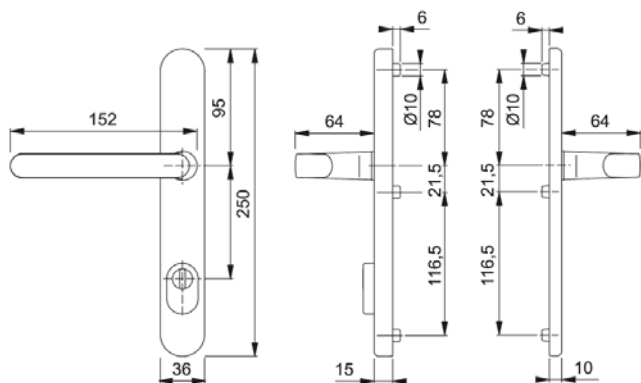
(147/ 1)

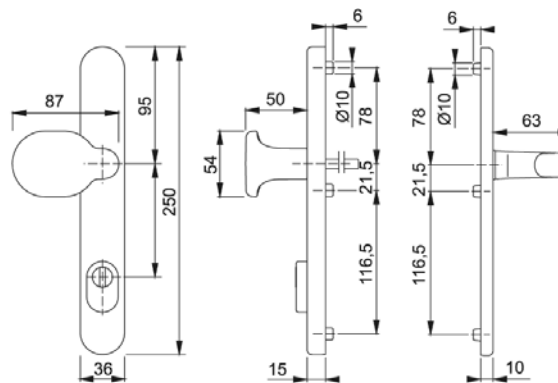
LUXEMBOURG
86G/3358/3357N-RF/1500

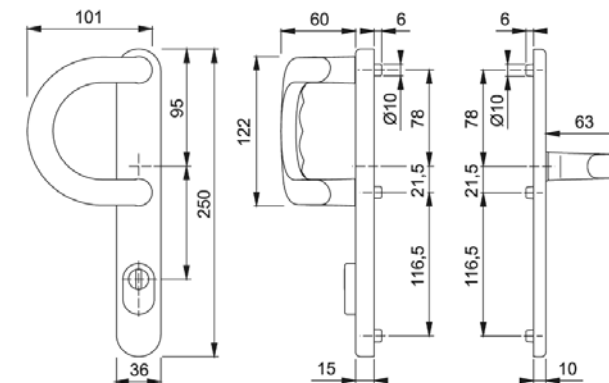
(147/ 2)

LUXEMBOURG
513G/3358/3357N-RF/1500

(147/ 3)

LUXEMBOURG
1500/3359ZA/3357N-RF

(147/ 4)

LUXEMBOURG
86G/3359ZA/3357N-RF/1500

(147/ 5)

LUXEMBOURG
513G/3359ZA/3357N-RF/1500

(147/ 6)



R.S.P. s.r.o.

SOUPRAVY PRO PROFILOVÉ DVEŘE - NÁKRESY

Hliník Nerez Mosaz Plast

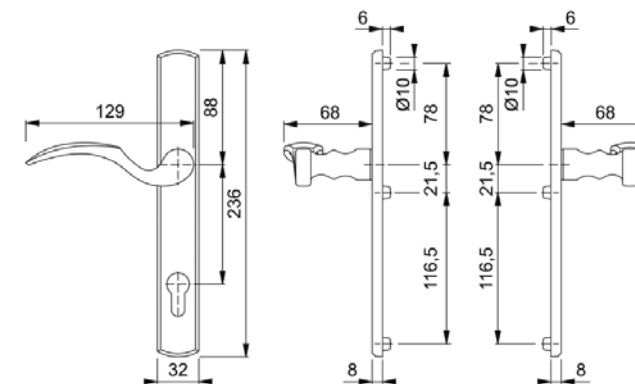
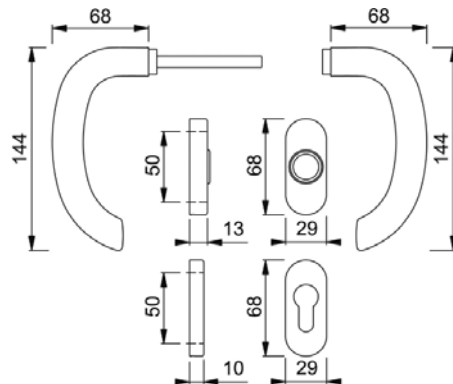
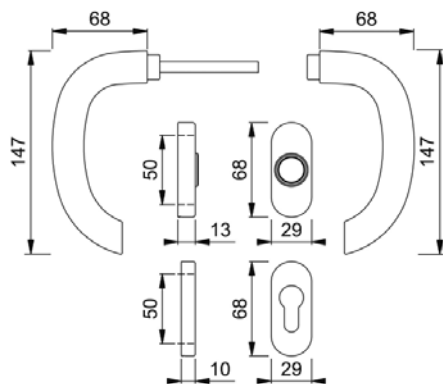

MARSEILLE (148/ 1)
1138/30P/30PS

MARSEILLE (148/ 2)
E1138Z/30P/30PS

MÜNCHEN (148/ 3)
M112SH/387N

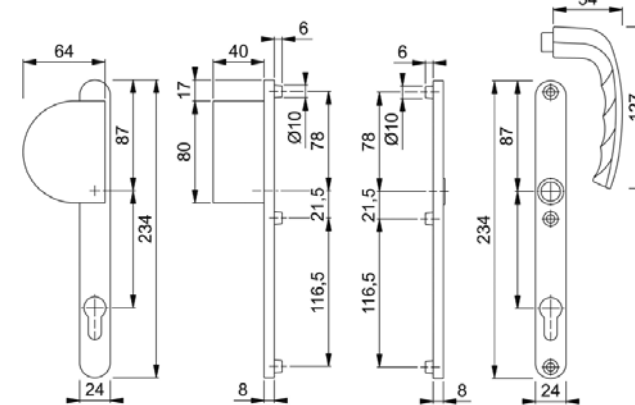
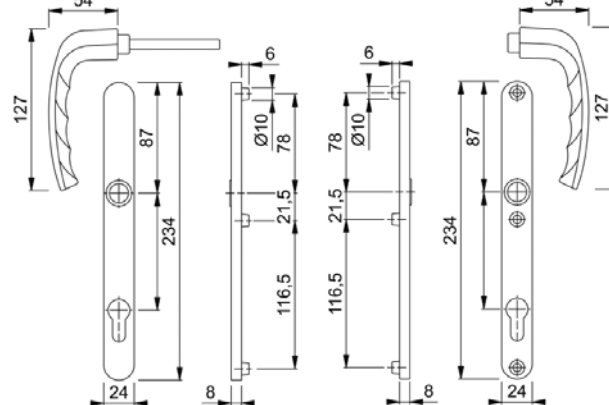
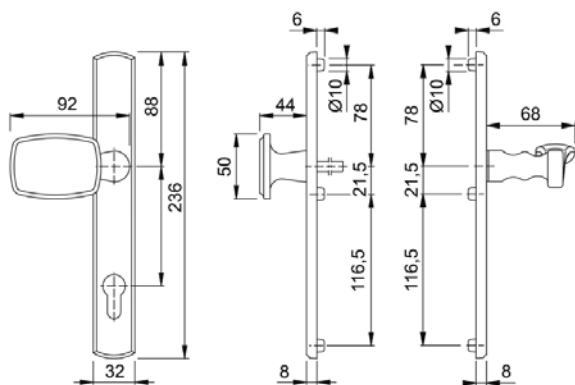

MÜNCHEN (148/ 4)
M52G/387N/112SH

NEW YORK (148/ 5)
1810/303N

NEW YORK (148/ 6)
554/303N/1810

© R.S.P. s.r.o. Týn nad Vltavou

Verze: HOP-SP-06.14

Platnost od: 15.03.2014

Tisk: 01.03.2014

Technické změny vyhrazeny!

148





SOUPRAVY PRO PROFILOVÉ DVEŘE - NÁKRESY

Hliník

Nerez

Mosaz

Plast

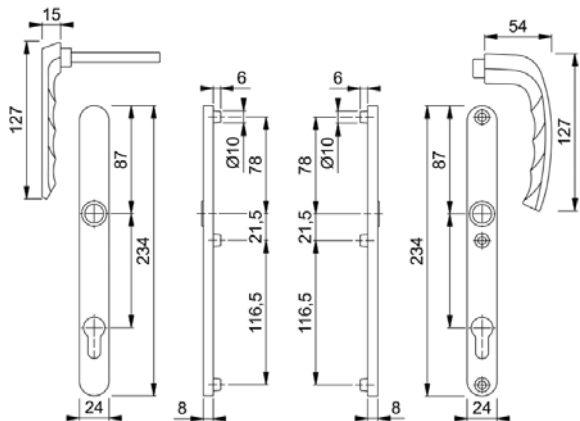

NEW YORK
099KH/303N/1810

(149/ 1)

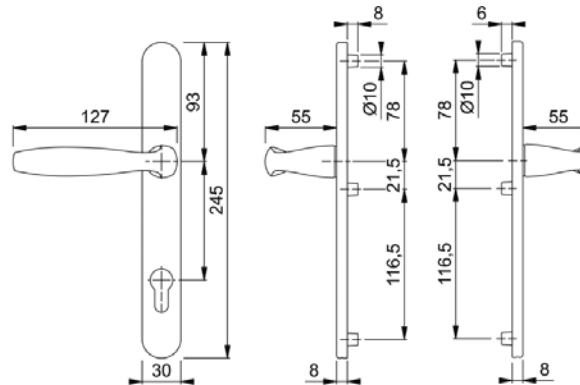

NEW YORK
1810/3346

(149/ 2)

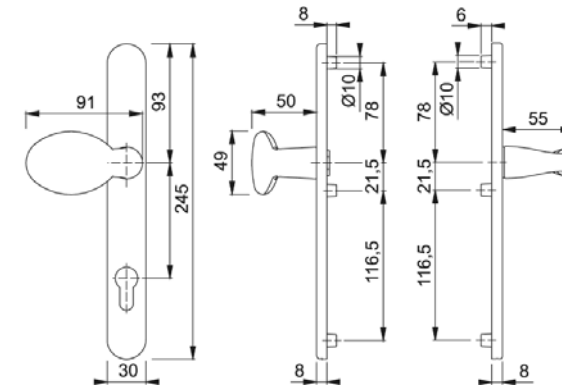

NEW YORK
76G/3346/1810

(149/ 3)

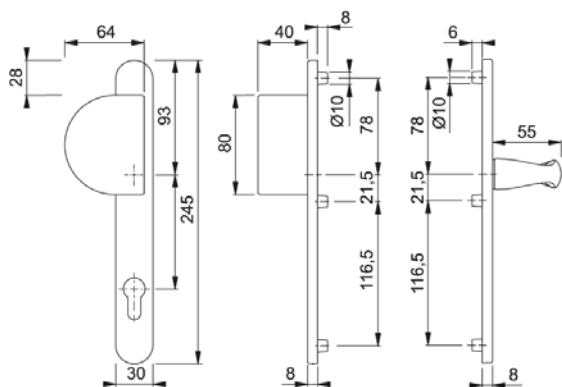

NEW YORK
554/3346/1810

(149/ 4)

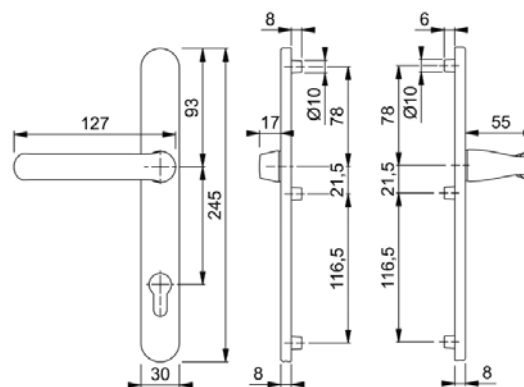

NEW YORK
099KH/3346/1810

(149/ 5)

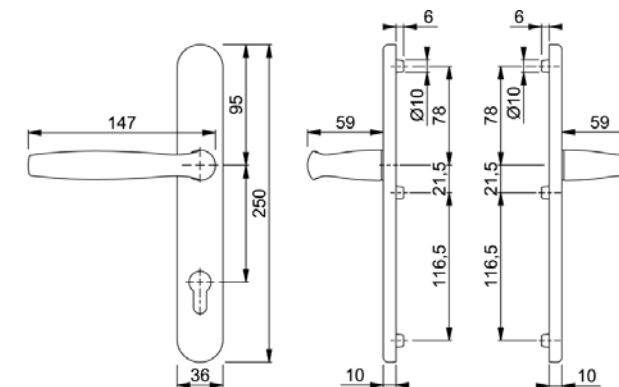

NEW YORK
1810G/3357N-RF

(149/ 6)





SOUPRAVY PRO PROFILOVÉ DVEŘE - NÁKRESY

Hliník

Nerez

Mosaz

Plast

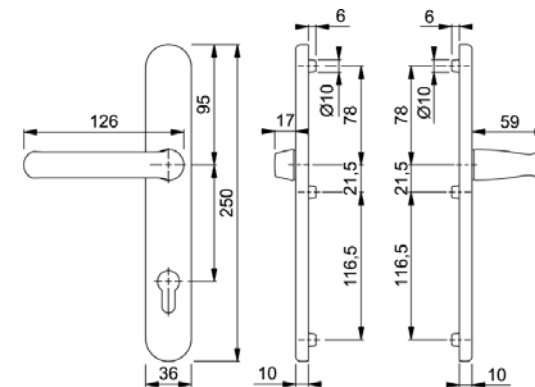
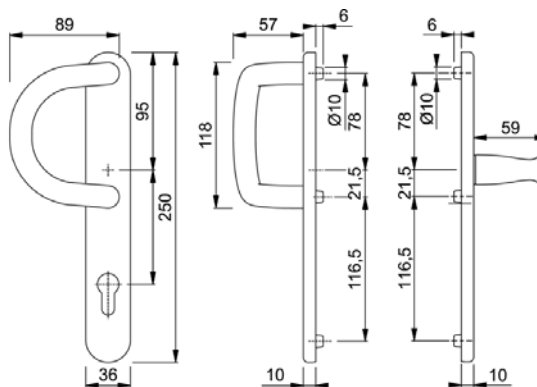
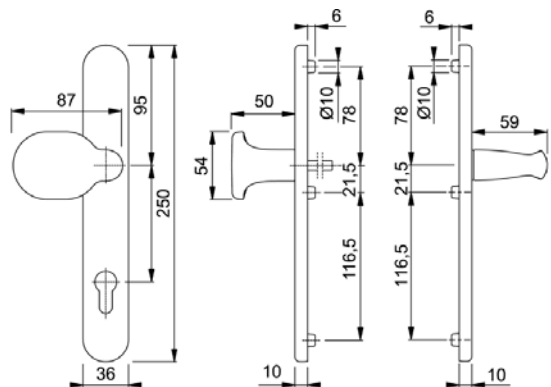

NEW YORK (150/ 1)
86G/3357N/3357N-RF/1810G

NEW YORK (150/ 2)
538G/3357N/3357N-RF/1810G

NEW YORK (150/ 3)
099KH/3357N/3357N-RF/1810G

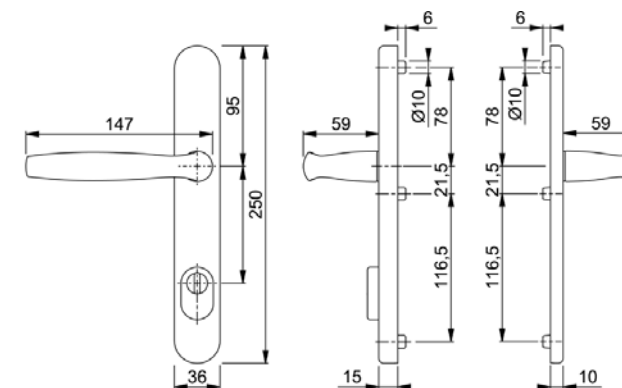
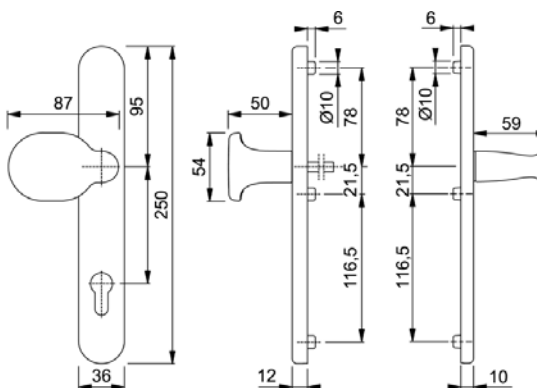
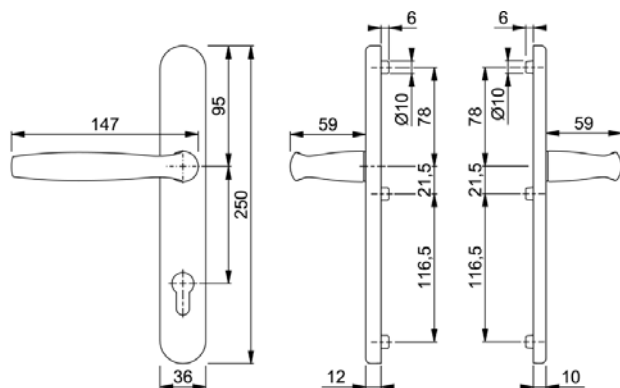

NEW YORK (150/ 4)
1810G/3358/3357N-RF

NEW YORK (150/ 5)
86G/3358/3357N-RF/1810G

NEW YORK (150/ 6)
1810G/3359ZA/3357N-RF





SOUPRAVY PRO PROFILOVÉ DVEŘE - NÁKRESY

Hliník

Nerez

Mosaz

Plast

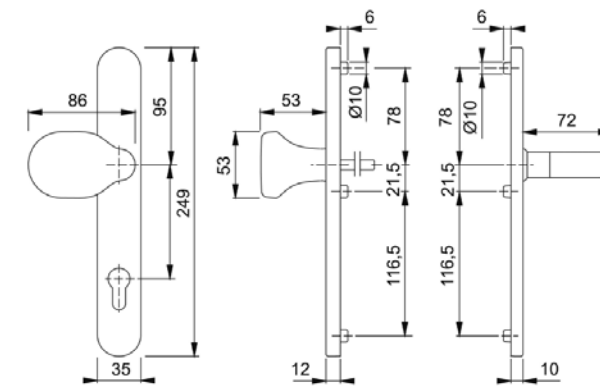
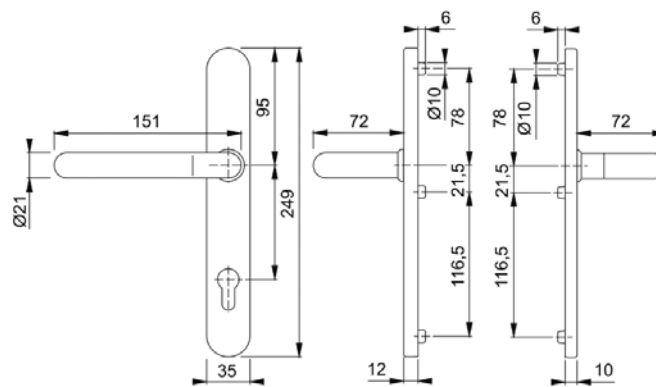
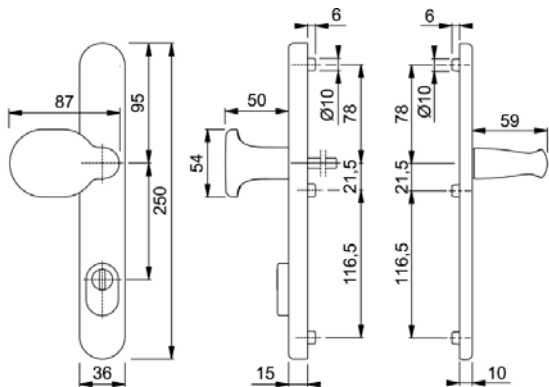

NEW YORK (151/ 1)
86G/3359ZA/3357N-RF/1810G

PARIS (151/ 2)
E138GF/3358/3357N-RF

PARIS (151/ 3)
E86G/3358/3357N-RF/138GF

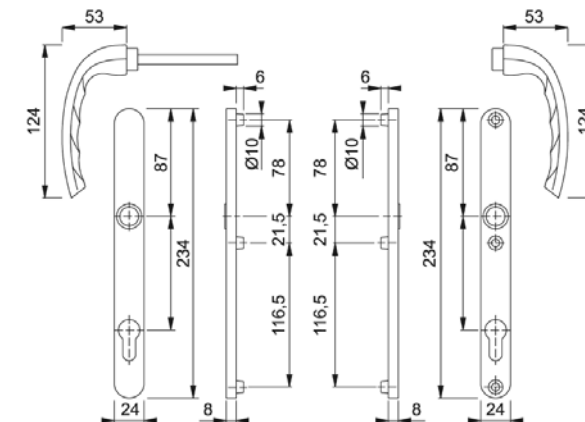
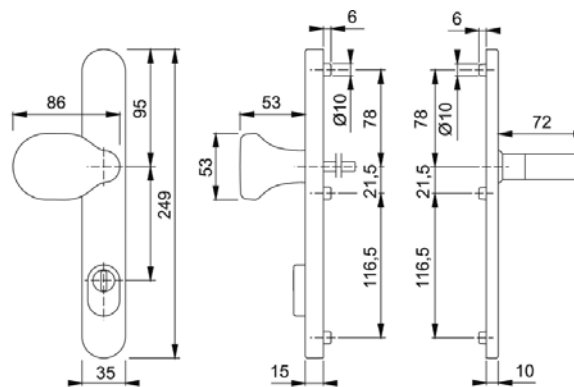
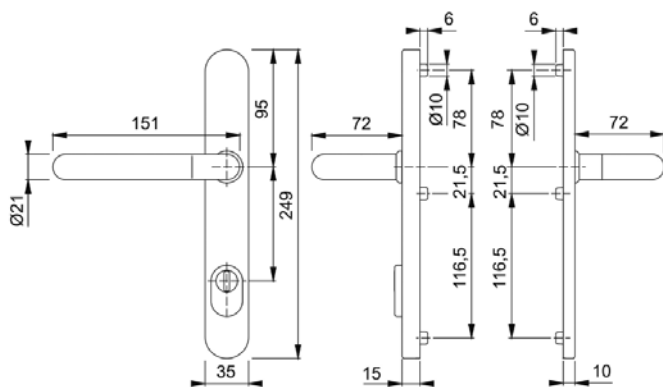

PARIS (151/ 4)
E138GF/3359ZA/3357N-RF

PARIS (151/ 5)
E86G/3359ZA/3357N-RF/138GF

TOKYO (151/ 6)
1710RH/303N

© R.S.P. s.r.o. Týn nad Vltavou

Verze: HOP-SP-06.14

Platnost od: 15.03.2014

Tisk: 01.03.2014

Technické změny vyhrazeny!





R.S.P. s.r.o.

SOUPRAVY PRO PROFILOVÉ DVEŘE - NÁKRESY

Hliník

Nerez

Mosaz

Plast

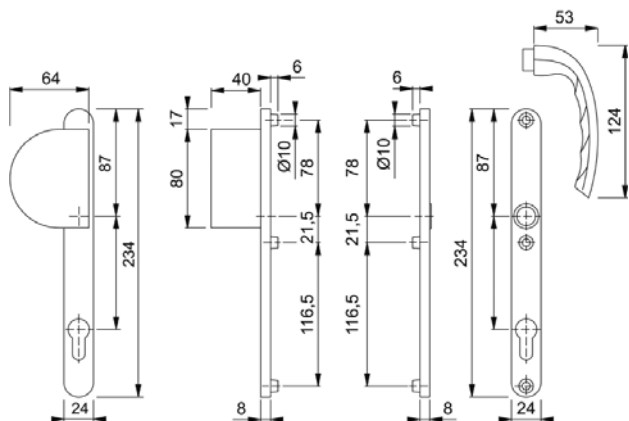

TOKYO
554/303N/1710RH

(152/ 1)

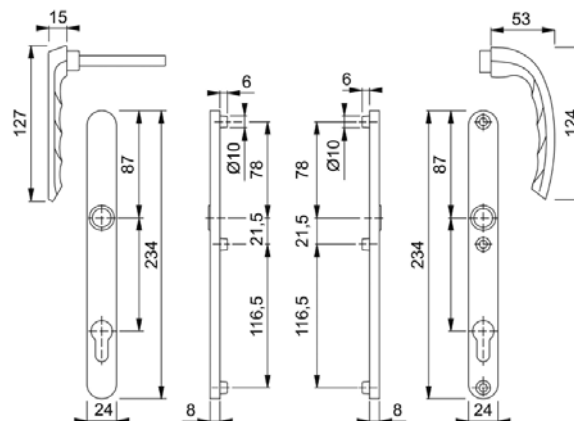

TOKYO
099KH/303N/1710RH

(152/ 2)

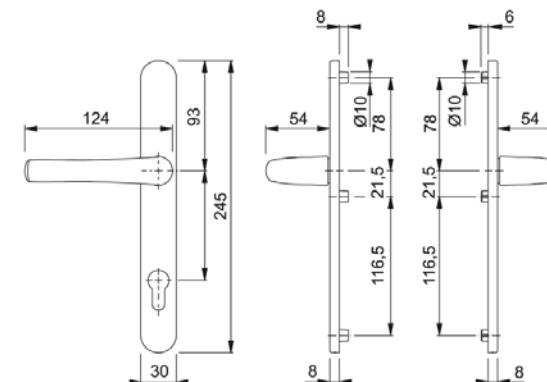

TOKYO
1710RH/3346

(152/ 3)

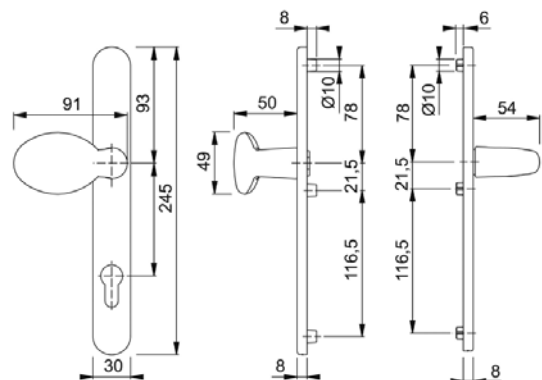

TOKYO
76G/3346/1710RH

(152/ 4)

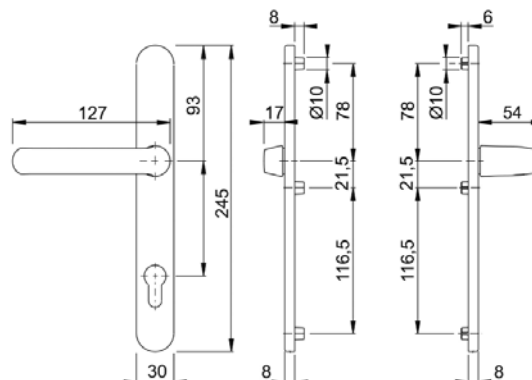

TOKYO
099KH/3346/1710RH

(152/ 5)





BEZPEČNOSTNÍ KOVÁNÍ

Hliník

Nerez



Mosaz

Plast

BIRMINGHAM 1117	154-156	TRONDHEIM E1430Z	195-198
DALLAS 1643	157-158	VERONA 1510	199-200
LONDON 113	159-168	VERONA E1800Z	201-202
MARSEILLE 1138	169-174	VERONA M151	203-204
MARSEILLE E1138Z	175-180	Kótované nákresy	205-216
MÜNCHEN M112SH	181		
NEW YORK 1810H	182-184		
PARIS 138L	185-186		
PARIS E138Z	187-188		
PARIS M138	189-190		
SAN FRANCISCO 1301	191-192		
STOCKHOLM E1140Z	193-194		





BEZPEČNOSTNÍ KOVÁNÍ
Hliník
Nerez
Mosaz
Plast

Vyobrazení	Obj. číslo	Čtyřhran			TS	Šroub	Kód barvy	Barevné provedení	Sklad	Cena brutto v Kč	
			SST								
	1117/2221A/2440							ES0	BIRMINGHAM		54 MM
	2550532	8	-	PZ/72	37-42	M6	F1	Elox přírodní	X	780,-	
	2550575	8	-	PZ/72	37-42	M6	F4	Elox bronz	X	897,-	
	54/2221A/2440/1117							ES0	BIRMINGHAM		54 MM
	2550292	8	-	PZ/72	37-42	M6	F1	Elox přírodní	X	780,-	
	2550313	8	-	PZ/72	37-42	M6	F4	Elox bronz	X	897,-	



BEZPEČNOSTNÍ KOVÁNÍ

							Hliník	Nerez	Mosaz	Plast
Vyobrazení	Obj. číslo	Čtyřhran		TS	Šroub	Kód barvy	Barevné provedení	Sklad	Cena brutto v Kč	
			SST							
	1117/2221A/2440						ES0	BIRMINGHAM		54 MM
	2952881	8	-	PZ/90	57-62	M6	F1	Elox přírodní	X	916,-
	3843011	8	-	PZ/90	37-42	M6	F4	Elox bronz	X	897,-
	54/2221A/2440/1117						ES0	BIRMINGHAM		54 MM
	2952785	8	-	PZ/90	57-62	M6	F1	Elox přírodní	X	916,-
	2952814	8	-	PZ/90	57-62	M6	F4	Elox bronz	X	1 033,-

















BEZPEČNOSTNÍ KOVÁNÍ

							Hliník	Nerez	Mosaz	Plast
Vyobrazení	Obj. číslo	Čtyřhran			TS	Šroub	Kód barvy	Barevné provedení	Sklad	Cena brutto v Kč
			SST							
	1117/2221A/2440						ES0	BIRMINGHAM		54 MM
	2904370	8	-	PZ/92	67-72	M6	F1	Elox přírodní		738,-
	2904388	8	-	PZ/92	67-72	M6	F4	Elox bronz		850,-
	54/2221A/2440/1117						ES0	BIRMINGHAM		54 MM
	2945542	8	-	PZ/92	67-72	M6	F1	Elox přírodní		738,-
	2904581	8	-	PZ/92	67-72	M6	F4	Elox bronz		853,-





BEZPEČNOSTNÍ KOVÁNÍ

							Hliník	Nerez	Mosaz	Plast
Vyobrazení	Obj. číslo	Čtyřhran		TS	Šroub	Kód barvy	Barevné provedení	Sklad	Cena brutto v Kč	
			SST							
Kótovaný náčr. Str./ poz. 205/ 3	1643/2221/2210					Tt3	DALLAS		54 MM	
	3767451	8		PZ/92	67-72	M6	F1	Elox přírodní		2 062,-
	3767477	8		PZ/92	67-72	M6	F4	Elox bronz		2 350,-
	3767469	8		PZ/92	67-72	M6	F9	Elox ocel		2 032,-
Kótovaný náčr. Str./ poz. 205/ 4	61G/2221/2210/1643					Tt3	DALLAS		54 MM	
	3767493	8		PZ/92	67-72	M6	F1	Elox přírodní		2 062,-
	3767514	8		PZ/92	67-72	M6	F4	Elox bronz		2 350,-
	3767506	8		PZ/92	67-72	M6	F9	Elox ocel		2 032,-



BEZPEČNOSTNÍ KOVÁNÍ

							Hliník	Nerez	Mosaz	Plast
Vyobrazení	Obj. číslo	Čtyřhran		TS	Šroub	Kód barvy	Barevné provedení	Sklad	Cena brutto v Kč	
			SST							
Kótovaný náčr. Str./ poz. 205/ 5	1643/2222ZA/2210					Tt3	DALLAS		54 MM	
	3767266	8		PZ/92	67-72	M6	F1	Elox přírodní	X	2 806,-
	3767282	8		PZ/92	67-72	M6	F4	Elox bronz	X	3 207,-
	3767274	8		PZ/92	67-72	M6	F9	Elox ocel	✓	2 772,-
Kótovaný náčr. Str./ poz. 205/ 6	61G/2222ZA/2210/1643					Tt3	DALLAS		54 MM	
	3767346	8		PZ/92	67-72	M6	F1	Elox přírodní	X	2 806,-
	3767400	8		PZ/92	67-72	M6	F4	Elox bronz	X	3 207,-
	3767354	8		PZ/92	67-72	M6	F9	Elox ocel	✓	2 772,-







BEZPEČNOSTNÍ KOVÁNÍ

Vyobrazení	Obj. číslo	Čtyřhran		TS	Šroub	Kód barvy	Hliník			Nerez			Mosaz			Plast			
			SST				Barevné provedení			Sklad			Cena brutto v Kč						
Kótovaný náčrtes Str./ poz. 206/ 1	113/2221/2220						Tt3	LONDON						54 MM					
	3164625	8	-	PZ/72	37-42	M6	F1	Elox přírodní			X			1 737,-					
	3164633	8	-	PZ/72	37-42	M6	F4	Elox bronz			X			1 998,-					
Kótovaný náčrtes Str./ poz. 206/ 2	78G/2221/2220/113						Tt3	LONDON						54 MM					
	3164537	8	-	PZ/72	37-42	M6	F1	Elox přírodní			X			1 737,-					
	3164545	8	-	PZ/72	37-42	M6	F4	Elox bronz			X			1 998,-					





BEZPEČNOSTNÍ KOVÁNÍ

							Hliník	Nerez	Mosaz	Plast
Vyobrazení	Obj. číslo	Čtyřhran		TS	Šroub	Kód barvy	Barevné provedení	Sklad	Cena brutto v Kč	
			SST							
Kótovaný náčr. Str./ poz. 206/ 3	113/2222ZA/2220					Tt3	LONDON		54 MM	
	3164668	8	-	PZ/72	37-42	M6	F1	Elox přírodní	X	2 481,-
	3164692	8	-	PZ/72	37-42	M6	F4	Elox bronz	X	2 853,-
Kótovaný náčr. Str./ poz. 206/ 4	78G/2222ZA/2220/113					Tt3	LONDON		54 MM	
	3164596	8	-	PZ/72	37-42	M6	F1	Elox přírodní	X	2 481,-
	3164609	8	-	PZ/72	37-42	M6	F4	Elox bronz	X	2 853,-



BEZPEČNOSTNÍ KOVÁNÍ
Hliník
Nerez
Mosaz
Plast

Vyobrazení	Obj. číslo	Čtyřhran		TS	Šroub	Kód barvy	Barevné provedení	Sklad	Cena brutto v Kč	
			SST							
<i>Kótovaný náčrsek Str./ poz. 206/ 5</i>	113/2221/2410					Tt2	LONDON		54 MM	
	3701339	8	-	PZ/72	37-42	M6	F1	Elox přírodní	X	1 416,-
	3701363	8	-	PZ/72	37-42	M6	F2	Elox alpaka	X	1 416,-
	3701398	8	-	PZ/72	37-42	M6	F4	Elox bronz	X	1 629,-
<i>Kótovaný náčrsek Str./ poz. 206/6</i>	78G/2221/2410/113					Tt2	LONDON		54 MM	
	3701751	8	-	PZ/72	37-42	M6	F1	Elox přírodní	X	1 416,-
	3701777	8	-	PZ/72	37-42	M6	F2	Elox alpaka	X	1 416,-
	3701793	8	-	PZ/72	37-42	M6	F4	Elox bronz	X	1 629,-





BEZPEČNOSTNÍ KOVÁNÍ

							Hliník	Nerez	Mosaz	Plast
Vyobrazení	Obj. číslo	Čtyřhran		TS	Šroub	Kód barvy	Barevné provedení	Sklad	Cena brutto v Kč	
			SST							
Kótovaný nákres Str./ poz. 207/ 1	113/2222ZA/2410					Tt2	LONDON		54 MM	
	3701419	8	-	PZ/72	37-42	M6	F1	Elox přírodní	2 117,-	
	3701443	8	-	PZ/72	37-42	M6	F2	Elox alpaka	2 117,-	
	3701486	8	-	PZ/72	37-42	M6	F4	Elox bronz	2 435,-	
Kótovaný nákres Str./ poz. 207/ 2	78G/2222ZA/2410/113					Tt2	LONDON		54 MM	
	3701822	8	-	PZ/72	37-42	M6	F1	Elox přírodní	2 117,-	
	3701911	8	-	PZ/72	37-42	M6	F2	Elox alpaka	2 117,-	
	3701970	8	-	PZ/72	37-42	M6	F4	Elox bronz	2 435,-	



BEZPEČNOSTNÍ KOVÁNÍ

							Hliník	Nerez	Mosaz	Plast
Vyobrazení	Obj. číslo	Čtyřhran		TS	Šroub	Kód barvy	Barevné provedení	Sklad	Cena brutto v Kč	
			SST							
Kótovaný náčr. Str./ poz. 207/ 3	113/2221/2210					Tt3	LONDON		54 MM	
	3907994	8	-	PZ/90	37-42	M6	F1	Elox přírodní		1 158,-
	3834772	8	-	PZ/90	37-42	M6	F4	Elox bronz		1 332,-
Kótovaný náčr. Str./ poz. 207/ 4	61G/2221/2210/113					Tt3	LONDON		54 MM	
	3907986	8	-	PZ/90	37-42	M6	F1	Elox přírodní		1 158,-
	3839872	8	-	PZ/90	37-42	M6	F4	Elox bronz		1 332,-





BEZPEČNOSTNÍ KOVÁNÍ

Hliník

Nerez







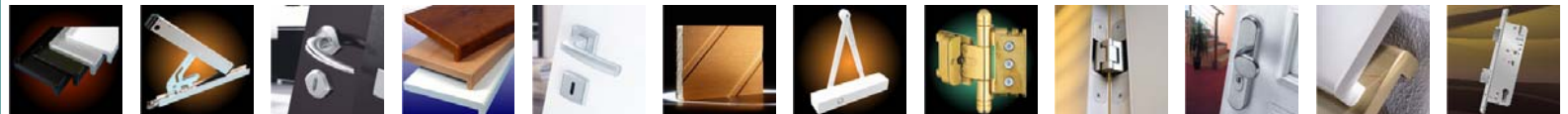





Mosaz

Plast

Vyobrazení	Obj. číslo	Čtyřhran		TS	Šroub	Kód barvy	Barevné provedení	Sklad	Cena brutto v Kč
			SST						
Kótovaný náčr. Str./ poz. 207/ 5	113/2222ZA/2210					Tt3	LONDON		54 MM
	3908014	8	-	PZ/90	37-42	M6	F1	Elox přírodní	1 705,-
	3834801	8	-	PZ/90	37-42	M6	F4	Elox bronz	1 960,-
Kótovaný náčr. Str./ poz. 207/ 6	61G/2222ZA/2210/113					Tt3	LONDON		54 MM
	3855426	8	-	PZ/90	37-42	M6	F1	Elox přírodní	1 705,-
	3834852	8	-	PZ/90	37-42	M6	F4	Elox bronz	1 960,-





BEZPEČNOSTNÍ KOVÁNÍ

								Hliník	Nerez	Mosaz	Plast
Vyobrazení	Obj. číslo	Čtyřhran		TS	Šroub	Kód barvy	Barevné provedení	Sklad	Cena brutto v Kč		
			SST								
Kótovaný náčrtes Str./ poz. 207/ 3	113/2221/2210						Tt3	LONDON		54 MM	
	3766263	8	-	PZ/92	67-72	M6	F1	Elox přírodní		1 370,-	
	3672822	8	-	PZ/92	67-72	M6	F2	Elox alpaka		1 610,-	
	3766280	8	-	PZ/92	67-72	M6	F4	Elox bronz		1 578,-	
	3725672	8	-	PZ/92	67-72	M6	F4/F9016	Elox bronz/ bílá		1 853,-	
	3766298	8	-	PZ/92	67-72	M6	F9016	Bílá		1 578,-	
Kótovaný náčrtes Str./ poz. 207/ 4	61G/2221/2210/113						Tt3	LONDON		54 MM	
	3766327	8	-	PZ/92	67-72	M6	F1	Elox přírodní		1 370,-	
	3673315	8	-	PZ/92	67-72	M6	F2	Elox alpaka		1 610,-	
	3766335	8	-	PZ/92	67-72	M6	F4	Elox bronz		1 578,-	
	3884235	8	-	PZ/92	67-72	M6	F4/F9016	Elox bronz/ bílá		1 853,-	
	3766351	8	-	PZ/92	67-72	M6	F9016	Bílá		1 578,-	





BEZPEČNOSTNÍ KOVÁNÍ

							Hliník	Nerez	Mosaz	Plast
Vyobrazení	Obj. číslo	Čtyřhran		TS	Šroub	Kód barvy	Barevné provedení	Sklad	Cena brutto v Kč	
			SST							
Kótovaný nákres Str./ poz. 207/ 5	113/2222ZA/2210					Tt3	LONDON		54 MM	
	3766108	8	-	PZ/92	67-72	M6	F1	Elox přírodní		2 035,-
	3725947	8	-	PZ/92	67-72	M6	F2	Elox alpaka		2 259,-
	3766132	8	-	PZ/92	67-72	M6	F4	Elox bronz	✓	2 343,-
	3726085	8	-	PZ/92	77-82	M6	F4/F9016	Elox bronz/ bílá	✓	2 343,-
	3766141	8	-	PZ/92	67-72	M6	F9016	Bílá	✓	2 343,-
Kótovaný nákres Str./ poz. 207/ 6	61G/2222ZA/2210/113					Tt3	LONDON		54 MM	
	3766204	8	-	PZ/92	67-72	M6	F1	Elox přírodní		2 035,-
	3855311	8	-	PZ/92	67-72	M6	F2	Elox alpaka		2 671,-
	3766221	8	-	PZ/92	67-72	M6	F4	Elox bronz	✓	2 343,-
	3884243	8	-	PZ/92	67-72	M6	F4/F9016	Elox bronz/ bílá	✓	2 343,-
	3766239	8	-	PZ/92	67-72	M6	F9016	Bílá	✓	2 343,-







BEZPEČNOSTNÍ KOVÁNÍ

							Hliník	Nerez	Mosaz	Plast
Vyobrazení	Obj. číslo	Čtýřhran		TS	Šroub	Kód barvy	Barevné provedení	Sklad	Cena brutto v Kč	
			SST							
Kótovaný nákres Str./ poz. 206/ 5	113/2221/2410					Tt2	LONDON		54 MM	
	3767178	8	-	PZ/92	66-71	M6	F1	Elox přírodní	X	1 547,-
	3725808	8	-	PZ/92	66-71	M6	F4	Elox bronz	X	1 759,-
	3725824	8	-	PZ/92	66-71	M6	F9016	Bílá	X	1 759,-
Kótovaný nákres Str./ poz. 206/ 6	78G/2221/2410/113					Tt2	LONDON		54 MM	
	3794061	8	-	PZ/92	66-71	M6	F1	Elox přírodní	X	1 547,-
	3731263	8	-	PZ/92	66-71	M6	F4	Elox bronz	X	1 759,-
	3731271	8	-	PZ/92	66-71	M6	F9016	Bílá	X	1 759,-













BEZPEČNOSTNÍ KOVÁNÍ

							Hliník	Nerez	Mosaz	Plast
Vyobrazení	Obj. číslo	Čtyřhran		TS	Šroub	Kód barvy	Barevné provedení	Sklad	Cena brutto v Kč	
			SST							
Kótovaný nákres Str./ poz. 207/ 1	113/2222ZA/2410					Tt2	LONDON		54 MM	
	3767119	8	-	PZ/92	66-71	M6	F1	Elox přírodní	X	2 247,-
	3726536	8	-	PZ/92	66-71	M6	F4	Elox bronz	X	2 565,-
	3726544	8	-	PZ/92	66-71	M6	F9016	Bílá	X	2 565,-
Kótovaný nákres Str./ poz. 207/ 2	78G/2222ZA/2410/113					Tt2	LONDON		54 MM	
	3701814	8-10-8	-	PZ/92	66-71	M6	F1	Elox přírodní	X	2 336,-
	3731280	8	-	PZ/92	66-71	M6	F4	Elox bronz	X	2 565,-
	3731298	8	-	PZ/92	66-71	M6	F9016	Bílá	X	2 565,-



BEZPEČNOSTNÍ KOVÁNÍ

Vyobrazení	Obj. číslo	Čtyřhran			TS	Šroub	Kód barvy	Hliník	Nerez	Mosaz	Plast	Cena brutto v Kč
			SST					Barevné provedení	Sklad			
Kótovaný nákres Str./ poz. 208/ 1	1138/3331/3330							Tt3	MARSEILLE			54 MM
	3459562	8		PZ/72	37-42	M6	F1	Elox přírodní				1 851,-
	3324545	8		PZ/72	37-42	M6	F4	Elox bronz				2 129,-
Kótovaný nákres Str./ poz. 208/ 2	76G/3331/3330/1138							Tt3	MARSEILLE			54 MM
	3336685	8		PZ/72	37-42	M6	F1	Elox přírodní				1 851,-
	3336677	8		PZ/72	37-42	M6	F4	Elox bronz				2 129,-















R.S.P. s.r.o.

BEZPEČNOSTNÍ KOVÁNÍ Hliník Nerez Mosaz Plast

Vyobrazení	Obj. číslo	Čtyřhran			TS	Šroub	Kód barvy	Barevné provedení	Sklad	Cena brutto v Kč
			SST							
Kótovaný nákres Str./ poz. 208/ 3	1138/3332ZA/3330						Tt3	MARSEILLE		54 MM
	3333290	8		PZ/72	37-42	M6	F1	Elox přírodní		1 790,-
	3333169	8		PZ/72	37-42	M6	F4	Elox bronz		2 059,-
Kótovaný nákres Str./ poz. 208/ 4	76G/3332ZA/3330/1138						Tt3	MARSEILLE		54 MM
	3338576	8		PZ/72	37-42	M6	F1	Elox přírodní		1 790,-
	3338568	8		PZ/72	37-42	M6	F4	Elox bronz		2 059,-





BEZPEČNOSTNÍ KOVÁNÍ

							Hliník	Nerez	Mosaz	Plast
Vyobrazení	Obj. číslo	Čtyřhran		TS	Šroub	Kód barvy	Barevné provedení	Sklad	Cena brutto v Kč	
			SST							
Kótovaný náčrsek Str./ poz. 208/ 5	1138/3331/3310					Tt3	MARSEILLE		54 MM	
	3909076	8		PZ/90	37-42	M6	F1	Elox přírodní		1 216,-
	3909084	8		PZ/90	37-42	M6	F4	Elox bronz		1 399,-
Kótovaný náčrsek Str./ poz. 208/ 6	86G/3331/3310/1138					Tt3	MARSEILLE		54 MM	
	3908920	8		PZ/90	37-42	M6	F1	Elox přírodní		1 216,-
	3908954	8		PZ/90	37-42	M6	F4	Elox bronz		1 399,-















BEZPEČNOSTNÍ KOVÁNÍ

							Hliník	Nerez	Mosaz	Plast
Vyobrazení	Obj. číslo	Čtyřhran		TS	Šroub	Kód barvy	Barevné provedení	Sklad	Cena brutto v Kč	
			SST							
Kótovaný náčr. Str./ poz. 209/ 1	1138/3332ZA/3310					Tt3	MARSEILLE		54 MM	
	3908962	8		PZ/90	37-42	M6	F1	Elox přírodní		1 790,-
	3908971	8		PZ/90	37-42	M6	F4	Elox bronz		2 059,-
Kótovaný náčr. Str./ poz. 209/ 2	86G/3332ZA/3310/1138					Tt3	MARSEILLE		54 MM	
	3775151	8		PZ/90	37-42	M6	F1	Elox přírodní		1 790,-
	3775178	8		PZ/90	37-42	M6	F4	Elox bronz		2 059,-





BEZPEČNOSTNÍ KOVÁNÍ

Vyobrazení	Obj. číslo	Čtyřhran		TS	Šroub	Kód barvy	Hliník			Nerez			Mosaz			Plast			
			SST					Barevné provedení			Sklad			Cena brutto v Kč					
Kótovaný náčrsek Str./ poz. 208/ 5	1138/3331/3310						Tt3	MARSEILLE						54 MM					
	3727328	8		PZ/92	67-72	M6	F1	Elox přírodní			✓			1 301,-					
	3727336	8		PZ/92	67-72	M6	F4	Elox bronz			✓			1 497,-					
	3953261	8		PZ/92	67-72	M6	F9	Elox ocel			✓			1 497,-					
	3727230	8		PZ/92	67-72	M6	F9016	Bílá			✓			1 497,-					
Kótovaný náčrsek Str./ poz. 208/ 6	86G/3331/3310/1138						Tt3	MARSEILLE						54 MM					
	3765130	8		PZ/92	67-72	M6	F1	Elox přírodní			✓			1 301,-					
	3765156	8		PZ/92	67-72	M6	F4	Elox bronz			✓			1 497,-					
	3953245	8		PZ/92	67-72	M6	F9	Elox ocel			✓			1 497,-					
	3765172	8		PZ/92	67-72	M6	F9016	Bílá			✓			1 497,-					



BEZPEČNOSTNÍ KOVÁNÍ

							Hliník	Nerez	Mosaz	Plast
Vyobrazení	Obj. číslo	Čtyřhran		TS	Šroub	Kód barvy	Barevné provedení	Sklad	Cena brutto v Kč	
			SST							
Kótovaný náčrtek Str./ poz. 209/ 1	1138/3332ZA/3310					Tt3	MARSEILLE		54 MM	
	3727344	8		PZ/92	67-72	M6	F1	Elox přírodní	✓	1 915,-
	3764971	8		PZ/92	67-72	M6	F4	Elox bronz	✓	2 202,-
	3953253	8		PZ/92	67-72	M6	F9	Elox ocel	✓	2 202,-
	3765009	8		PZ/92	67-72	M6	F9016	Bílá	✓	2 202,-
Kótovaný náčrtek Str./ poz. 209/ 2	86G/3332ZA/3310/1138					Tt3	MARSEILLE		54 MM	
	3765076	8		PZ/92	67-72	M6	F1	Elox přírodní	✓	1 915,-
	3765113	8		PZ/92	67-72	M6	F4	Elox bronz	✓	2 202,-
	3953165	8		PZ/92	67-72	M6	F9	Elox ocel	✓	2 202,-
	3765121	8		PZ/92	67-72	M6	F9016	Bílá	✓	2 202,-



BEZPEČNOSTNÍ KOVÁNÍ

Hliník

Nerez

Mosaz

Plast

Vyobrazení	Obj. číslo	Čtyřhran		TS	Šroub	Kód barvy	Barevné provedení	Sklad	Cena brutto v Kč
			SST						
<p>Kótovaný náčr. Str./ poz. 209/ 3</p>	E1138Z/3331/3310						Tt3	MARSEILLE	53 MM
	3663686	8		PZ/72	37-42	M6	F69	Nerez matná	X
<p>Kótovaný náčr. Str./ poz. 209/ 4</p>	E86G/3331/3310/1138Z						Tt3	MARSEILLE	53 MM
	3663766	8		PZ/72	42-47	M6	F69	Nerez matná	X







BEZPEČNOSTNÍ KOVÁNÍ Hliník Nerez Mosaz Plast

Vyobrazení	Obj. číslo	Čtyřhran		TS	Šroub	Kód barvy	Barevné provedení	Sklad	Cena brutto v Kč
			SST						
	E1138Z/3332ZA/3310						Tt3	MARSEILLE	53 MM
	3663731	8		PZ/72	37-42	M6	F69	Nerez matná	X
	E86G/3332ZA/3310/1138Z						Tt3	MARSEILLE	53 MM
	3663838	8		PZ/72	42-47	M6	F69	Nerez matná	X



BEZPEČNOSTNÍ KOVÁNÍ
Hliník
Nerez
Mosaz
Plast

Vyobrazení	Obj. číslo	Čtyřhran		TS	Šroub	Kód barvy	Barevné provedení	Sklad	Cena brutto v Kč
			SST						
	E1138Z/3331/3310						Tt3	MARSEILLE	53 MM
	-	8		PZ/90	37-42	M6	F69	Nerez matná 	1 870,-
	E86G/3331/3310/1138Z						Tt3	MARSEILLE	53 MM
	-	8		PZ/90	37-42	M6	F69	Nerez matná 	1 870,-



BEZPEČNOSTNÍ KOVÁNÍ
Hliník
Nerez
Mosaz
Plast

Vyobrazení	Obj. číslo	Čtyřhran			TS	Šroub	Kód barvy	Barevné provedení	Sklad	Cena brutto v Kč
			SST							
	E1138Z/3332ZA/3310							Tt3	MARSEILLE	53 MM
	3460838	8		PZ/90	37-42	M6	F69	Nerez matná		2 181,-
	E86G/3332ZA/3310/1138Z							Tt3	MARSEILLE	53 MM
	3797705	8		PZ/90	37-42	M6	F69	Nerez matná		2 181,-





BEZPEČNOSTNÍ KOVÁNÍ

Hliník

Nerez



Mosaz

Plast

Vyobrazení	Obj. číslo	Čtyřhran		TS	Šroub	Kód barvy	Barevné provedení	Sklad	Cena brutto v Kč
			SST						
<p>Kótovaný náčr. Str./ poz. 209/ 3</p>	E1138Z/3331/3310						Tt3	MARSEILLE	53 MM
	3727571	8		PZ/92	67-72	M6	F69	Nerez matná	✓
<p>Kótovaný náčr. Str./ poz. 209/ 4</p>	E86G/3331/3310/1138Z						Tt3	MARSEILLE	53 MM
	3727707	8		PZ/92	67-72	M6	F69	Nerez matná	✓















BEZPEČNOSTNÍ KOVÁNÍ
Hliník
Nerez
Mosaz
Plast

Vyobrazení	Obj. číslo	Čtýřhran		TS	Šroub	Kód barvy	Barevné provedení	Sklad	Cena brutto v Kč
			SST						
Kótovaný náčres Str./ poz. 209/ 5	E1138Z/3332ZA/3310					Tt3	MARSEILLE		53 MM
	3727598	8		PZ/92	67-72	M6	F69	Nerez matná ✓	2 285,-
Kótovaný náčres Str./ poz. 209/ 6	E86G/3332ZA/3310/1138Z					Tt3	MARSEILLE		53 MM
	3727731	8		PZ/92	67-72	M6	F69	Nerez matná ✓	2 285,-





BEZPEČNOSTNÍ KOVÁNÍ
Hliník
Nerez
Mosaz
Plast

Vyobrazení	Obj. číslo	Čtyřhran			TS	Šroub	Kód barvy	Barevné provedení	Sklad	Cena brutto v Kč
			SST							
 <p>Resista 10-letá záruka na povrchovou úpravu</p>	M112SH/334A/333N							MÜNCHEN		55/56 MM
	626076(L)	8	-	PZ/92	67-72	M6	F73	Mosaz brynýrovaná		2 686,-
	620036(L)	8	-	PZ/92	67-72	M6	F77-R	Mosaz lesklá- Resista ®		2 686,-
	626069(R)	8	-	PZ/92	67-72	M6	F73	Mosaz brynýrovaná		2 686,-
	620029(R)	8	-	PZ/92	67-72	M6	F77-R	Mosaz lesklá- Resista ®		2 686,-
	M57/334A/333N/112SH							MÜNCHEN		55/56 MM
	626090(L)	8	-	PZ/92	67-72	M6	F73	Mosaz brynýrovaná		2 686,-
	619931(L)	8	-	PZ/92	67-72	M6	F77-R	Mosaz lesklá- Resista ®		2 686,-
	626083(R)	8	-	PZ/92	67-72	M6	F73	Mosaz brynýrovaná		2 686,-
	619924(R)	8	-	PZ/92	67-72	M6	F77-R	Mosaz lesklá- Resista ®		2 686,-













BEZPEČNOSTNÍ KOVÁNÍ

							Hliník	Nerez	Mosaz	Plast
Vyobrazení	Obj. číslo	Čtyřhran		TS	Šroub	Kód barvy	Barevné provedení	Sklad	Cena brutto v Kč	
			SST							
Kótovaný náčrtes Str./ poz. 210/ 3	1810H/3331/3410					Tt2	NEW YORK		54 MM	
	3767522	8		PZ/92	66-71	M6	F1	Elox přírodní	✓	921,-
	3730586	8		PZ/92	66-71	M6	F4	Elox bronz	✓	1 053,-
	3730800	8		PZ/92	66-71	M6	F9	Elox ocel	✓	1 053,-
	3767565	8		PZ/92	66-71	M6	F9016	Bílá	✓	1 053,-
Kótovaný náčrtes Str./ poz. 210/ 4	76G/3331/3410/1810H					Tt2	NEW YORK		54 MM	
	3767670	8		PZ/92	66-71	M6	F1	Elox přírodní	✓	921,-
	3767717	8		PZ/92	66-71	M6	F4	Elox bronz	✓	1 053,-
	3712943	8-10-8		PZ/92	66-71	M6	F9	Elox ocel	✓	1 053,-
	3767725	8		PZ/92	66-71	M6	F9016	Bílá	✓	1 053,-





BEZPEČNOSTNÍ KOVÁNÍ

							Hliník	Nerez	Mosaz	Plast
Vyobrazení	Obj. číslo	Čtyřhran		TS	Šroub	Kód barvy	Barevné provedení	Sklad	Cena brutto v Kč	
			SST							
Kótovaný náčrsek Str./ poz. 210/ 5	1810H/3332ZA/3410					Tt2	NEW YORK		54 MM	
	3767291	8		PZ/92	66-71	M6	F1	Elox přírodní	✓	1 463,-
	3767338	8		PZ/92	66-71	M6	F4	Elox alpaka	✓	1 673,-
	3712732	8-10-8		PZ/92	66-71	M6	F9	Elox ocel	✓	1 673,-
	3767362	8		PZ/92	66-71	M6	F9016	Bílá	✓	1 673,-
Kótovaný náčrsek Str./ poz. 210/ 6	76G/3332ZA/3410/1810H					Tt2	NEW YORK		54 MM	
	3767418	8		PZ/92	66-71	M6	F1	Elox přírodní	✓	1 463,-
	3767434	8		PZ/92	66-71	M6	F4	Elox alpaka	✓	1 673,-
	3712628	8-10-8		PZ/92	66-71	M6	F9	Elox ocel	✓	1 673,-
	3767442	8		PZ/92	66-71	M6	F9016	Bílá	✓	1 673,-

















BEZPEČNOSTNÍ KOVÁNÍ

							Hliník	Nerez	Mosaz	Plast
Vyobrazení	Obj. číslo	Čtyřhran		TS	Šroub	Kód barvy	Barevné provedení	Sklad	Cena brutto v Kč	
			SST							
Kótovaný náčrtek Str./ poz. 210/ 5	1810H/3332ZA/3410					Tt2	NEW YORK		54 MM	
	3664734	8		PZ/72	36-41	M6	F1	Elox přírodní	X	1 463,-
	-	8		PZ/72	36-41	M6	F4	Elox bronz	X	1 673,-
	3712767	8		PZ/72	36-41	M6	F9	Elox ocel	X	1 673,-
Kótovaný náčrtek Str./ poz. 210/ 6	76G/3332ZA/3410/1810H					Tt2	NEW YORK		54 MM	
	3664849	8		PZ/72	41-46	M6	F1	Elox přírodní	X	1 463,-
	-	8		PZ/72	36-41	M6	F4	Elox bronz	X	1 673,-
	3712687	8		PZ/72	36-41	M6	F9	Elox ocel	X	1 673,-





BEZPEČNOSTNÍ KOVÁNÍ

							Hliník	Nerez	Mosaz	Plast
Vyobrazení	Obj. číslo	Čtyřhran		TS	Šroub	Kód barvy	Barevné provedení	Sklad	Cena brutto v Kč	
			SST							
Kótovaný náčrsek Str./ poz. 211/ 1	138L/3331/3310					Tt3	PARIS		54 MM	
	3765551	8		PZ/92	67-72	M6	F1	Elox přírodní		1 521,-
	3664902	8-10-8		PZ/92	67-72	M6	F2	Elox alpaka		1 782,-
	3765607	8		PZ/92	67-72	M6	F4	Elox bronz	✓	1 749,-
	3765658	8		PZ/92	67-72	M6	F9016	Bílá	✓	1 749,-
Kótovaný náčrsek Str./ poz. 211/ 2	86G/3331/3310/138L					Tt3	PARIS		54 MM	
	3765674	8		PZ/92	67-72	M6	F1	Elox přírodní		1 521,-
	-	8		PZ/92	67-72	M6	F2	Elox alpaka		1 782,-
	3765682	8		PZ/92	67-72	M6	F4	Elox bronz	✓	1 749,-
	3765711	8		PZ/92	67-72	M6	F9016	Bílá	✓	1 749,-











BEZPEČNOSTNÍ KOVÁNÍ

							Hliník	Nerez	Mosaz	Plast
Vyobrazení	Obj. číslo	Čtyřhran		TS	Šroub	Kód barvy	Barevné provedení	Sklad	Cena brutto v Kč	
			SST							
Kótovaný náčrtek Str./ poz. 211/ 3	138L/3332ZA/3310					Tt3	PARIS		54 MM	
	3765199	8		PZ/92	67-72	M6	F1	Elox přírodní		2 183,-
	-	8		PZ/92	67-72	M6	F2	Elox alpaka		2 426,-
	3765210	8		PZ/92	67-72	M6	F4	Elox bronz	✓	2 514,-
	3765236	8		PZ/92	67-72	M6	F9016	Bílá	✓	2 514,-
Kótovaný náčrtek Str./ poz. 211/ 4	86G/3332ZA/3310/138L					Tt3	PARIS		54 MM	
	3765252	8		PZ/92	67-72	M6	F1	Elox přírodní		2 183,-
	-	8		PZ/92	67-72	M6	F2	Elox alpaka		2 426,-
	3765279	8		PZ/92	67-72	M6	F4	Elox bronz	✓	2 514,-
	3765308	8		PZ/92	67-72	M6	F9016	Bílá	✓	2 514,-



BEZPEČNOSTNÍ KOVÁNÍ
Hliník
Nerez
Mosaz
Plast

Vyobrazení	Obj. číslo	Čtyřhran			TS	Šroub	Kód barvy	Barevné provedení	Sklad	Cena brutto v Kč
			SST							
	E138Z/3331/3310							Tt3	PARIS	53 MM
	3812098	8		PZ/92	67-72	M6	F69	Nerez matná		4 329,-
	E86G/3331/3310/138Z							Tt3	PARIS	53 MM
	3812143	8		PZ/92	67-72	M6	F69	Nerez matná		4 329,-





R.S.P. s.r.o.

BEZPEČNOSTNÍ KOVÁNÍ Hliník Nerez Mosaz Plast

Vyobrazení	Obj. číslo	Čtýřhran			TS	Šroub	Kód barvy	Barevné provedení	Sklad	Cena brutto v Kč
			SST							
Kótovaný náčres Str./ poz. 212/ 1	E138Z/3332ZA/3310			Tt3	PARIS	53 MM				
	3813162	8		PZ/92	67-72	M6	F69	Nerez matná		4 659,-
Kótovaný náčres Str./ poz. 212/ 2	E86G/3332ZA/3310/138Z			Tt3	PARIS	53 MM				
	3797668	8		PZ/92	67-72	M6	F69	Nerez matná		4 659,-

© R.S.P. s.r.o. Týn nad Vltavou

Verze: HOP-SP-06.14









Platnost od: 15.03.2014

Tisk: 01.03.2014

Technické změny vyhrazeny!





BEZPEČNOSTNÍ KOVÁNÍ
Hliník
Nerez
Mosaz
Plast

Vyobrazení	Obj. číslo	Čtyřhran			TS	Šroub	Kód barvy	Barevné provedení	Sklad	Cena brutto v Kč
			SST							
 <p>BEZPEČNOSTNÍ TŘÍDA T63 ČSNPENY 1027 ČSNPENY 1030</p> <p>Resista® 10-letá záruka na povrchovou úpravu</p>	Kótovaný náčr. Str./ poz. 212/ 3	M138L/3331/3310					Tt3	PARIS		53 MM
	3669164	8-10-8		PZ/92	67-72	M6	F77-R	Mosaz lesklá- Resista®		5 215,-
 <p>BEZPEČNOSTNÍ TŘÍDA T63 ČSNPENY 1027 ČSNPENY 1030</p> <p>Resista® 10-letá záruka na povrchovou úpravu</p>	Kótovaný náčr. Str./ poz. 212/ 4	M86G/3331/3310/138L					Tt3	PARIS		53 MM
	3669252	8-10-8		PZ/92	67-72	M6	F77-R	Mosaz lesklá- Resista®		5 215,-







BEZPEČNOSTNÍ KOVÁNÍ
Hliník
Nerez
Mosaz
Plast

Vyobrazení	Obj. číslo	Čtyřhran			TS	Šroub	Kód barvy	Barevné provedení	Sklad	Cena brutto v Kč
			SST							
 <p>BEZPEČNOSTNÍ TŘÍDA 1b3 ČSNPENY 1027 ČSNPENY 1030</p> <p>Resista 10-ti letá záruka na povrchovou úpravu</p>	M138L/3332ZA/3310							Tt3	PARIS	53 MM
	3669228	8-10-8		PZ/92	67-72	M6	F77-R	Mosaz lesklá- Resista [®]		5 985,-
 <p>BEZPEČNOSTNÍ TŘÍDA 1b3 ČSNPENY 1027 ČSNPENY 1030</p> <p>Resista 10-ti letá záruka na povrchovou úpravu</p>	M86G/3332ZA/3310/138L							Tt3	PARIS	53 MM
	3669404	8-10-8		PZ/92	67-72	M6	F77-R	Mosaz lesklá- Resista [®]		5 985,-





BEZPEČNOSTNÍ KOVÁNÍ							Hliník	Nerez	Mosaz	Plast
Vyobrazení	Obj. číslo	Čtyřhran		TS	Šroub	Kód barvy	Barevné provedení	Sklad	Cena brutto v Kč	
			SST							
<i>Kótovaný nákres Str./ poz. 213/ 1</i>	1301/3331/3310					Tt3	SAN FRANCISCO		54 MM	
	3715925	8-10-8		PZ/92	67-72	M6	F1	Elox přírodní	X	2 009,-
	3715933	8-10-8		PZ/92	67-72	M6	F9	Elox ocel	X	2 310,-
<i>Kótovaný nákres Str./ poz. 213/ 2</i>	86G/3331/3310/1301					Tt3	SAN FRANCISCO		54 MM	
	3715845	8-10-8		PZ/92	67-72	M6	F1	Elox přírodní	X	2 009,-
	3715853	8-10-8		PZ/92	67-72	M6	F9	Elox ocel	X	2 310,-



BEZPEČNOSTNÍ KOVÁNÍ

							Hliník	Nerez	Mosaz	Plast
Vyobrazení	Obj. číslo	Čtyřhran		TS	Šroub	Kód barvy	Barevné provedení	Sklad	Cena brutto v Kč	
			SST							
Kótovaný nákres Str./ poz. 213/ 3	1301/3332ZA/3310					Tt3	SAN FRANCISCO		54 MM	
	3716071	8-10-8		PZ/92	67-72	M6	F1	Elox přírodní	X	2 462,-
	3716080	8-10-8		PZ/92	67-72	M6	F9	Elox ocel	X	2 831,-
Kótovaný nákres Str./ poz. 213/ 4	86G/3332ZA/3310/1301					Tt3	SAN FRANCISCO		54 MM	
	3715968	8-10-8		PZ/92	67-72	M6	F1	Elox přírodní	X	2 462,-
	3715976	8-10-8		PZ/92	67-72	M6	F9	Elox ocel	X	2 831,-









BEZPEČNOSTNÍ KOVÁNÍ							Hliník	Nerez	Mosaz	Plast
Vyobrazení	Obj. číslo	Čtyřhran		TS	Šroub	Kód barvy	Barevné provedení	Sklad	Cena brutto v Kč	
			SST							
Kótovaný nákres Str./ poz. 213/ 5	E1140Z/3331/3310						Tt3	STOCKHOLM		53 MM
	3811896	8		PZ/92	67-72	M6	F69	Nerez matná	X	3 923,-
Kótovaný nákres Str./ poz. 213/ 6	E86G/3331/3310/1140Z						Tt3	STOCKHOLM		53 MM
	3665024	8-10-8		PZ/92	67-72	M6	F69	Nerez matná	X	3 923,-





R.S.P. s.r.o.

BEZPEČNOSTNÍ KOVÁNÍ Hliník Nerez Mosaz Plast

Vyobrazení	Obj. číslo	Čtyřhran			TS	Šroub	Kód barvy	Barevné provedení	Sklad	Cena brutto v Kč	
			SST								
Kótovaný nákres Str./ poz. 214/ 1	E1140Z/3332ZA/3310							Tt3	STOCKHOLM		53 MM
	3821681	8		PZ/92	67-72	M6	F69	Nerez matná	X	5 056,-	
Kótovaný nákres Str./ poz. 214/ 2	E86G/3332ZA/3310/1140Z							Tt3	STOCKHOLM		53 MM
	3828891	8		PZ/92	67-72	M6	F69	Nerez matná	X	5 056,-	

© R.S.P. s.r.o. Týn nad Vltavou

Verze: HOP-SP-06.14





Platnost od: 15.03.2014

Tisk: 01.03.2014

Technické změny vyhrazeny!





BEZPEČNOSTNÍ KOVÁNÍ
Hliník
Nerez
Mosaz
Plast

Vyobrazení	Obj. číslo	Čtyřhran		TS	Šroub	Kód barvy	Barevné provedení	Sklad	Cena brutto v Kč
			SST						
	E1430Z/3331/3310						Tt3	TRONDHEIM	53 MM
	3776390	8		PZ/90	37-42	M6	F69	Nerez matná	X
	E86G/3331/3310/1430Z						Tt3	TRONDHEIM	53 MM
	3776509	8		PZ/90	37-42	M6	F69	Nerez matná	X





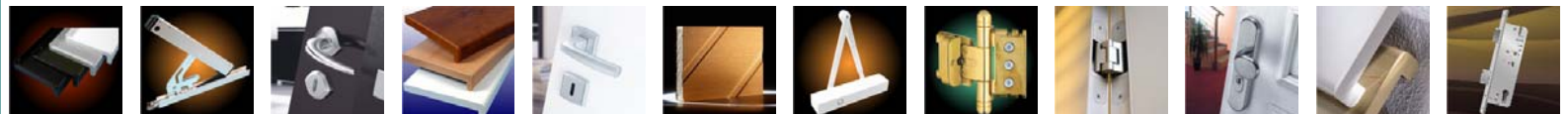

BEZPEČNOSTNÍ KOVÁNÍ
Hliník
Nerez
Mosaz
Plast

Vyobrazení	Obj. číslo	Čtyřhran			TS	Šroub	Kód barvy	Barevné provedení	Sklad	Cena brutto v Kč
			SST							
	E1430Z/3332ZA/3310							Tt3	TRONDHEIM	53 MM
	3776082	8		PZ/90	37-42	M6	F69	Nerez matná	X	4 992,-
	E86G/3332ZA/3310/1430Z							Tt3	TRONDHEIM	53 MM
	3776509	8		PZ/90	37-42	M6	F69	Nerez matná	X	4 992,-





BEZPEČNOSTNÍ KOVÁNÍ
Hliník
Nerez
Mosaz
Plast

Vyobrazení	Obj. číslo	Čtýřhran		TS	Šroub	Kód barvy	Barevné provedení	Sklad	Cena brutto v Kč
			SST						
	E1430Z/3331/3310						Tt3	TRONDHEIM	53 MM
	3776306	8		PZ/92	67-72	M6	F69	Nerez matná	X
	E86G/3331/3310/1430Z						Tt3	TRONDHEIM	53 MM
	3716426	8		PZ/92	67-72	M6	F69	Nerez matná	X



















BEZPEČNOSTNÍ KOVÁNÍ

							Hliník	Nerez	Mosaz	Plast
Vyobrazení	Obj. číslo	Čtýřhran		TS	Šroub	Kód barvy	Barevné provedení	Sklad	Cena brutto v Kč	
			SST							
	E1430Z/3332ZA/3310						Tt3	TRONDHEIM		53 MM
	3727660	8		PZ/92	67-72	M6	F69	Nerez matná		4 550,-
	E86G/3332ZA/3310/1430Z						Tt3	TRONDHEIM		53 MM
	3873296	8		PZ/92	67-72	M6	F69	Nerez matná		4 550,-





BEZPEČNOSTNÍ KOVÁNÍ								Hliník	Nerez	Mosaz	Plast
Vyobrazení	Obj. číslo	Čtyřhran		TS	Šroub	Kód barvy	Barevné provedení	Sklad	Cena brutto v Kč		
			SST								
<i>Kótovaný nákres Str./ poz. 215/ 1</i>	1510/3331/3310					Tt3	VERONA		54 MM		
	3766950	8		PZ/92	67-72	M6	F1	Elox přírodní		1 521,-	
	-	8		PZ/92	67-72	M6	F2	Elox alpaka		1 788,-	
	3766976	8		PZ/92	67-72	M6	F4	Elox bronz	✓	1 749,-	
	3766968	8		PZ/92	67-72	M6	F9	Elox ocel		1 749,-	
	3766984	8		PZ/92	67-72	M6	F9016	Bílá	✓	1 749,-	
<i>Kótovaný nákres Str./ poz. 215/ 2</i>	86G/3331/3310/1510					Tt3	VERONA		54 MM		
	3766992	8		PZ/92	67-72	M6	F1	Elox přírodní		1 521,-	
	-	8		PZ/92	67-72	M6	F2	Elox alpaka		1 788,-	
	3767012	8		PZ/92	67-72	M6	F4	Elox bronz	✓	1 749,-	
	3767004	8		PZ/92	67-72	M6	F9	Elox ocel		1 749,-	
	3767021	8		PZ/92	67-72	M6	F9016	Bílá	✓	1 749,-	





R.S.P. s.r.o.

BEZPEČNOSTNÍ KOVÁNÍ

Hliník

Nerez

Mosaz

Plast

Vyobrazení	Obj. číslo	Čtyřhran			TS	Šroub	Kód barvy	Barevné provedení	Sklad	Cena brutto v Kč	
			SST								
Kótovaný náskres Str./ poz. 215/ 3	1510/3332ZA/3310						Tt3	VERONA			
	3766386	8		PZ/92	67-72	M6	F1	Elox přírodní		2 183,-	
	-	8		PZ/92	67-72	M6	F2	Elox alpaka		2 426,-	
	3766440	8		PZ/92	67-72	M6	F4	Elox bronz		2 514,-	
	3766423	8		PZ/92	67-72	M6	F9	Elox ocel		2 514,-	
	3766466	8		PZ/92	67-72	M6	F9016	Bílá		2 514,-	
Kótovaný náskres Str./ poz. 215/ 4	86G/3332ZA/3310/1510						Tt3	VERONA			
	3766491	8		PZ/92	67-72	M6	F1	Elox přírodní		2 183,-	
	-	8		PZ/92	67-72	M6	F2	Elox alpaka		2 426,-	
	3766933	8		PZ/92	67-72	M6	F4	Elox bronz		2 514,-	
	3766511	8		PZ/92	67-72	M6	F9	Elox ocel		2 514,-	
	3766941	8		PZ/92	67-72	M6	F9016	Bílá		2 514,-	

© R.S.P. s.r.o. Týn nad Vltavou

Verze: HOP-SP-06.14







Platnost od: 15.03.2014

Tisk: 01.03.2014

Technické změny vyhrazeny!

200









BEZPEČNOSTNÍ KOVÁNÍ							Hliník	Nerez	Mosaz	Plast
Vyobrazení	Obj. číslo	Čtyřhran			TS	Šroub	Kód barvy	Barevné provedení	Sklad	Cena brutto v Kč
			SST							
Kótovaný nákres Str./ poz. 215/ 5	E1800Z/3331/3310						Tt3	VERONA		53 MM
	3812055	8		PZ/92	67-72	M6	F69	Nerez matná		4 381,-
Kótovaný nákres Str./ poz. 215/ 6	E86G/3331/3310/1800Z						Tt3	VERONA		53 MM
	3845826	8		PZ/92	67-72	M6	F69	Nerez matná		4 381,-











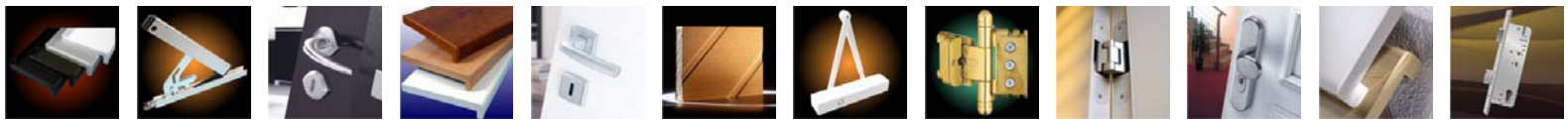



R.S.P. s.r.o.

BEZPEČNOSTNÍ KOVÁNÍ Hliník Nerez Mosaz Plast

Vyobrazení	Obj. číslo	Čtýřhran			TS	Šroub	Kód barvy	Barevné provedení	Sklad	Cena brutto v Kč
			SST							
Kótovaný nákres Str./ poz. 216/ 1	E1800Z/3332ZA/3310						Tt3	VERONA		53 MM
	3821664	8		PZ/92	67-72	M6	F69	Nerez matná		4 988,-
Kótovaný nákres Str./ poz. 216/ 2	E86G/3332ZA/3310/1800Z						Tt3	VERONA		53 MM
	3813226	8		PZ/92	67-72	M6	F69	Nerez matná		4 988,-





BEZPEČNOSTNÍ KOVÁNÍ

							Hliník	Nerez	Mosaz	Plast
Vyobrazení	Obj. číslo	Čtyřhran		TS	Šroub	Kód barvy	Barevné provedení	Sklad	Cena brutto v Kč	
			SST							
Kótovaný náčrsek Str./ poz. 216/ 3	M151/3331/3310					Tt3	VERONA		53 MM	
 <p>Resista® 10-ti letá záruka na povrchovou úpravu</p>	3670026	8-10-8		PZ/92	67-72	M6	F49-R	Chrom- Resista®	X	7 147,-
	3670042	8-10-8		PZ/92	67-72	M6	F77-R	Mosaz lesklá- Resista®	X	5 215,-
	3670093	8-10-8		PZ/92	67-72	M6	F98-R	Chrom matný- Resista®	X	8 409,-
Kótovaný náčrsek Str./ poz. 216/ 4	M86G/3331/3310/151					Tt3	VERONA		53 MM	
 <p>Resista® 10-ti letá záruka na povrchovou úpravu</p>	3670413	8-10-8		PZ/92	67-72	M6	F49-R	Chrom- Resista®	X	7 147,-
	3670421	8-10-8		PZ/92	67-72	M6	F77-R	Mosaz lesklá- Resista®	X	5 215,-
	3670405	8-10-8		PZ/92	67-72	M6	F98-R	Chrom matný- Resista®	X	8 409,-



BEZPEČNOSTNÍ KOVÁNÍ

							Hliník	Nerez	Mosaz	Plast
Vyobrazení	Obj. číslo	Čtyřhran		TS	Šroub	Kód barvy	Barevné provedení	Sklad	Cena brutto v Kč	
			SST							
Kótovaný náčr. Str./ poz. 216/ 5	M151/3332ZA/3310					Tt3	VERONA		53 MM	
 <p>Resista 10-ti letá záruka na povrchovou úpravu</p>	3670165	8-10-8		PZ/92	67-72	M6	F49-R	Chrom- Resista [®]		8 039,-
	3731829	8		PZ/92	67-72	M6	F77-R	Mosaz lesklá- Resista [®]		5 993,-
	3670270	8-10-8		PZ/92	67-72	M6	F98-R	Chrom matný- Resista [®]		9 300,-
Kótovaný náčr. Str./ poz. 216/ 6	M86G/3332ZA/3310/151					Tt3	VERONA		53 MM	
 <p>Resista 10-ti letá záruka na povrchovou úpravu</p>	3670536	8-10-8		PZ/92	67-72	M6	F49-R	Chrom- Resista [®]		8 039,-
	3731861	8		PZ/92	67-72	M6	F77-R	Mosaz lesklá- Resista [®]		5 993,-
	3670499	8-10-8		PZ/92	67-72	M6	F98-R	Chrom matný- Resista [®]		9 300,-



BEZPEČNOSTNÍ KOVÁNÍ - NÁKRESY

Hliník

Nerez

Mosaz

Plast

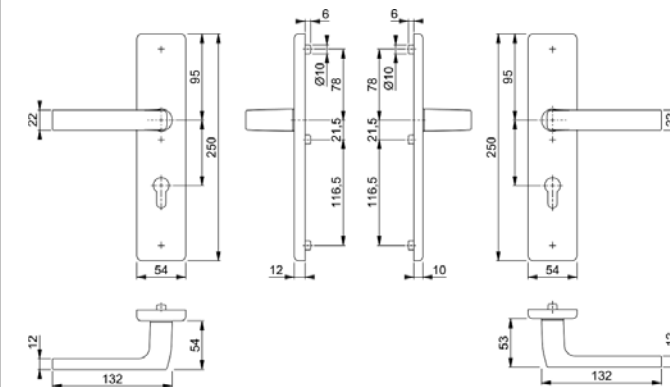
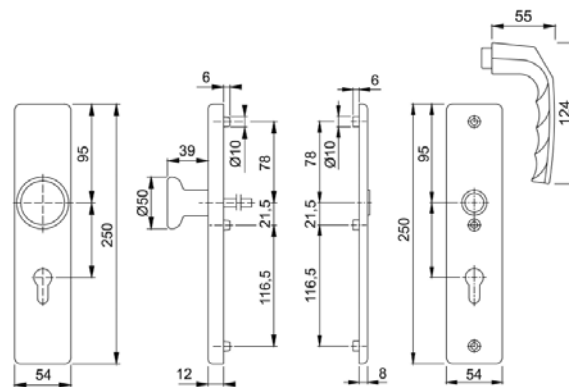
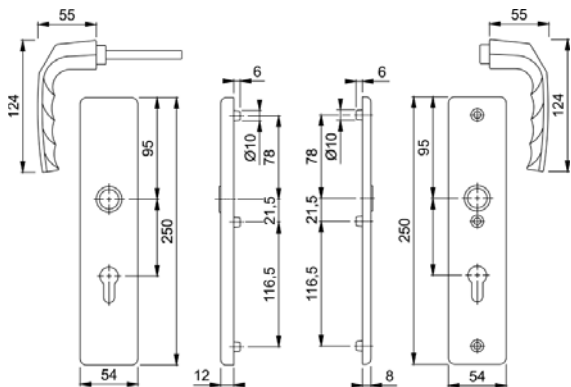

BIRMINGHAM
1117/2221A/2440

(205/ 1)

BIRMINGHAM
54/2221A/2440/1117

(205/ 2)

DALLAS
1643/2221/2210

(205/ 3)

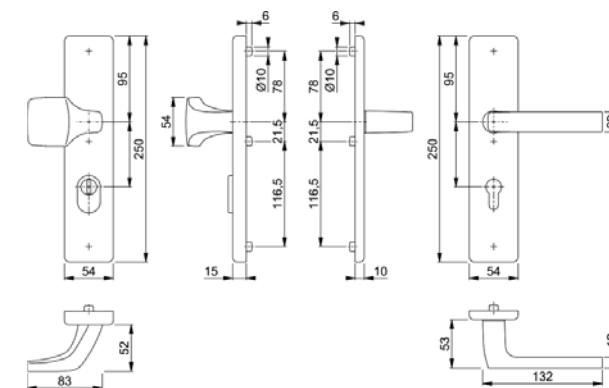
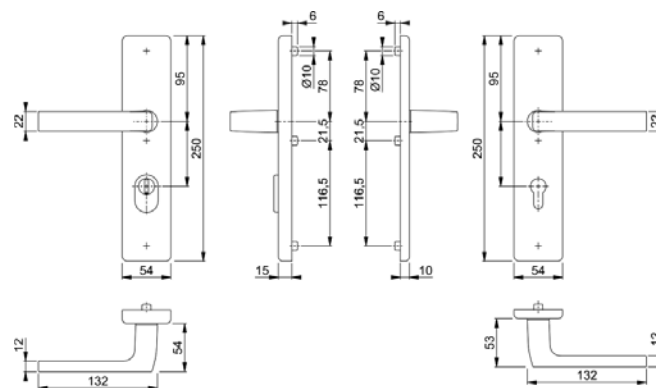
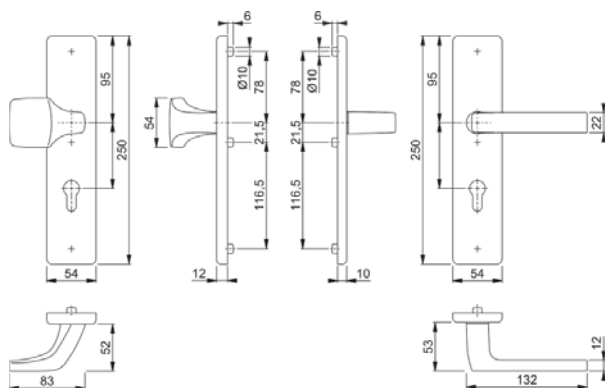

DALLAS
61G/2221/2210/1643

(205/ 4)

DALLAS
1643/2222ZA/2210

(205/ 5)

DALLAS
61G/2222ZA/2210/1643

(205/ 6)

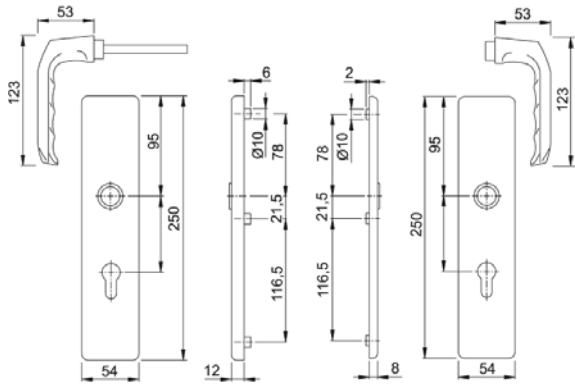

BEZPEČNOSTNÍ KOVÁNÍ - NÁKRESY
Hliník
Nerez
Mosaz
Plast

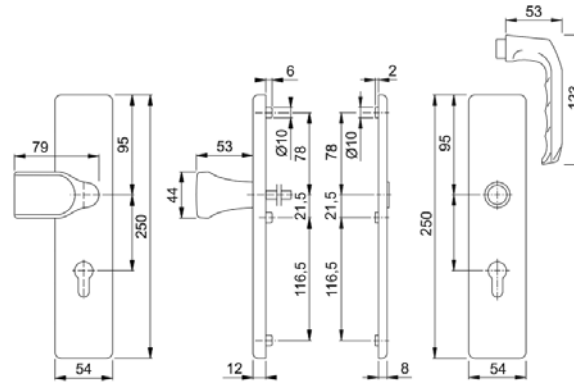
LONDON
113/2221/2220

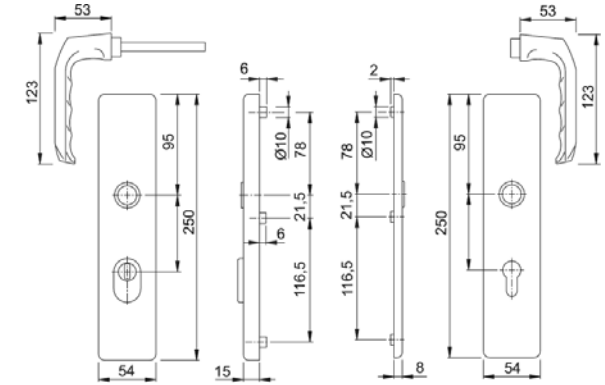
(206/ 1)

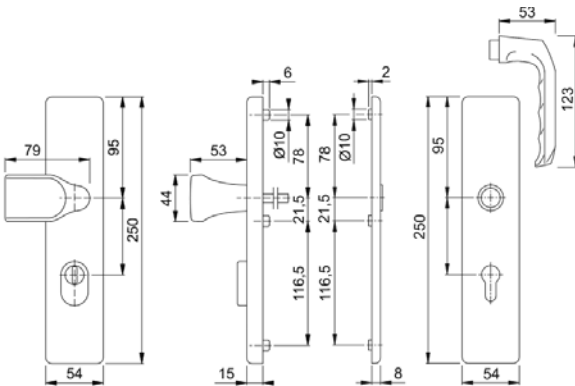
LONDON
78G/2221/2220/113

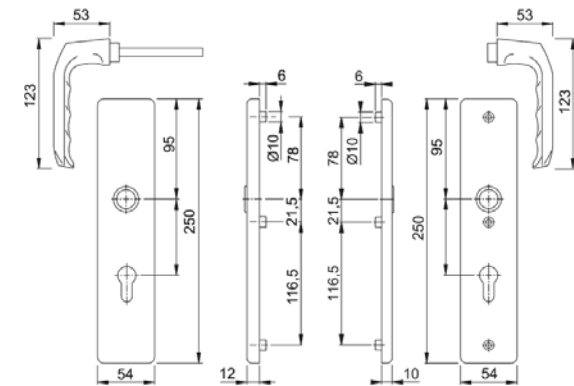
(206/ 2)

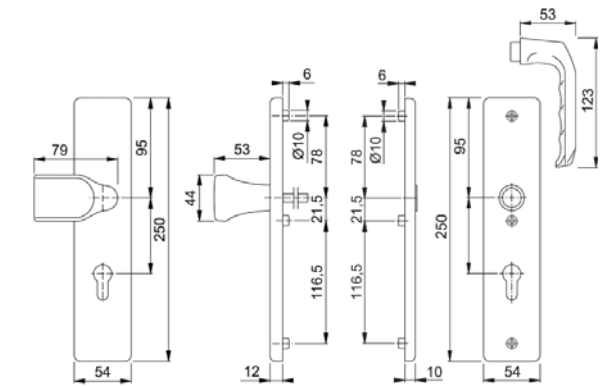
LONDON
113/2222ZA/2220

(206/ 3)

LONDON
78G/2222ZA/2220/113

(206/ 4)

LONDON
113/2221/2410

(206/ 5)

LONDON
78G/2221/2410/113

(206/ 6)

© R.S.P. s.r.o. Týn nad Vltavou

Verze: HOP-SP-06.14

Platnost od: 15.03.2014

Tisk: 01.03.2014

Technické změny vyhrazeny!



BEZPEČNOSTNÍ KOVÁNÍ - NÁKRESY

Hliník

Nerez

Mosaz

Plast

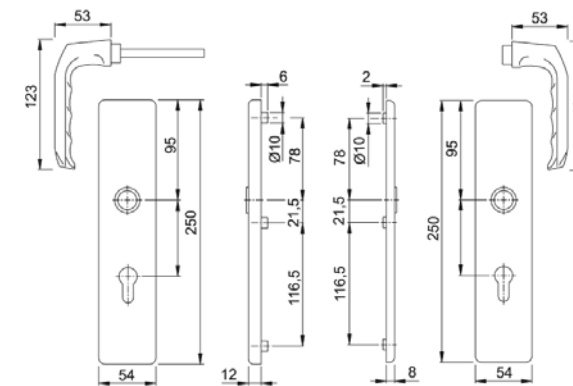
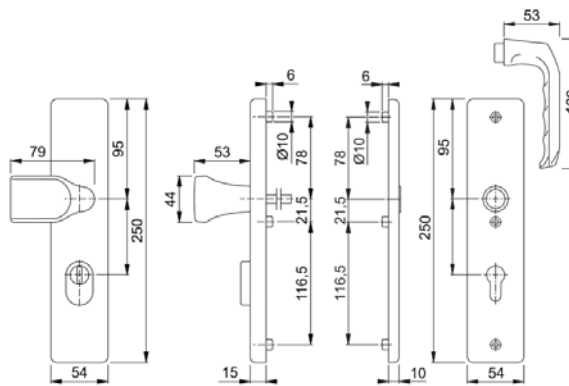
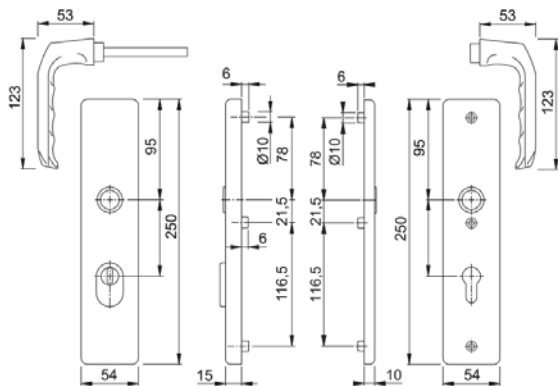

LONDON
113/2222ZA/2410

(207/ 1)

LONDON
78G/2222ZA/2410/113

(207/ 2)

LONDON
113/2221/2210

(207/ 3)

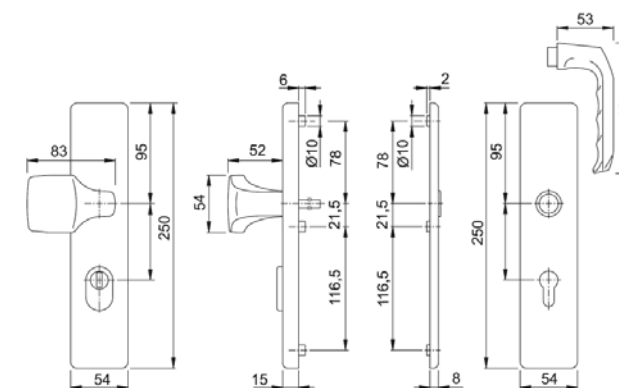
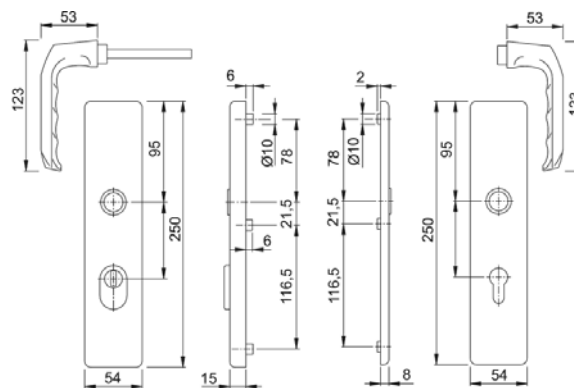
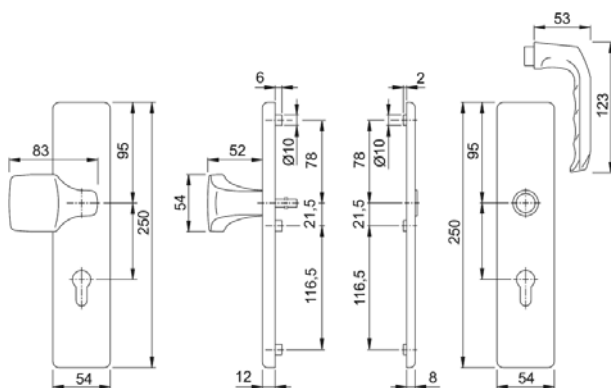

LONDON
61G/2221/2210/113

(207/ 4)

LONDON
113/2222ZA/2210

(207/ 5)

LONDON
61G/2222ZA/2210/113

(207/ 6)

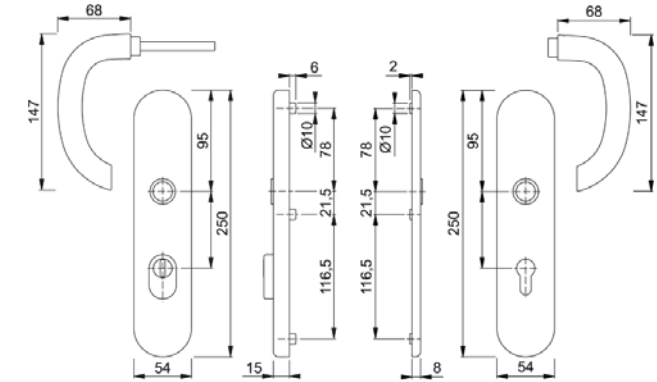
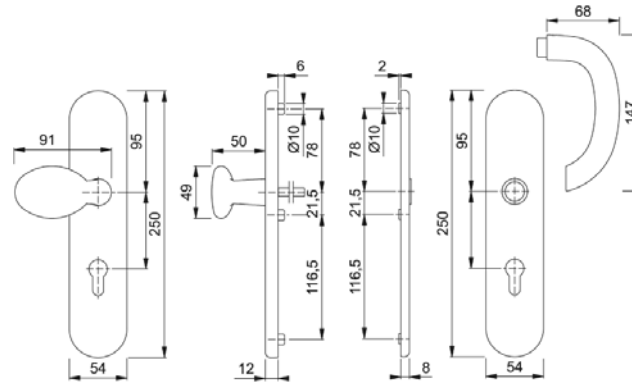
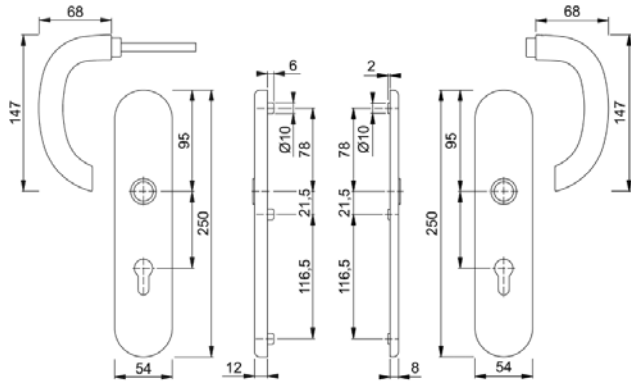

BEZPEČNOSTNÍ KOVÁNÍ - NÁKRESY
Hliník
Nerez
Mosaz
Plast

MARSEILLE
1138/3331/3330

(208/ 1)
MARSEILLE
76G/3331/3330/1138

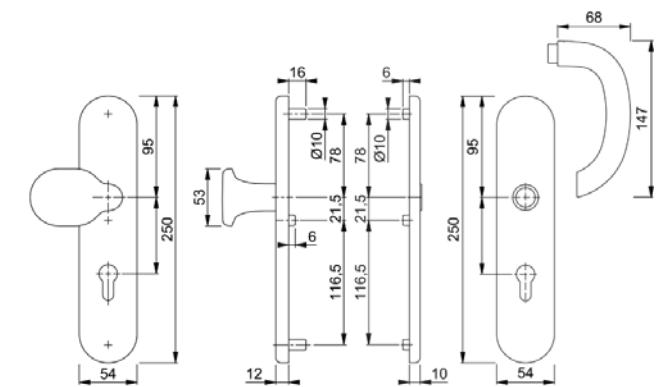
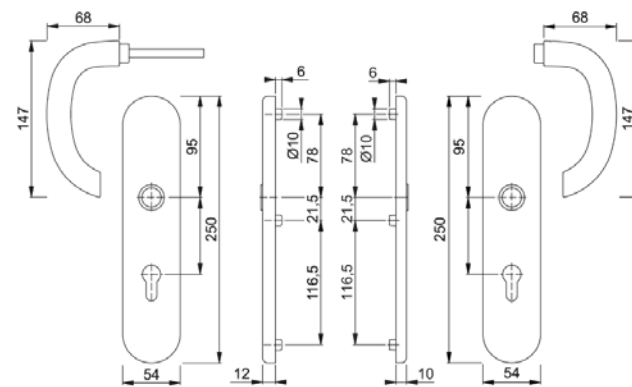
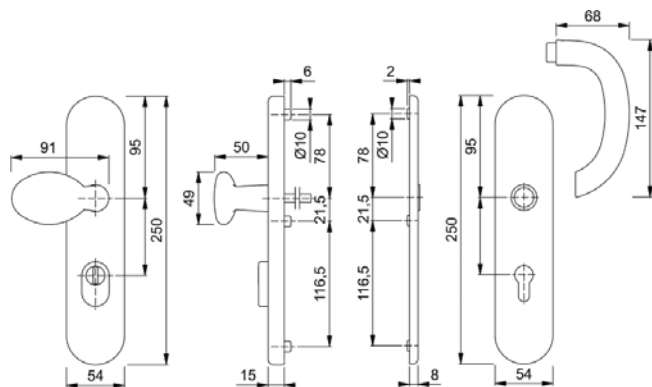
(208/ 2)
MARSEILLE
1138/3332ZA/3330

(208/ 3)

MARSEILLE
76G/3332ZA/3330/1138

(208/ 4)
MARSEILLE
1138/3331/3310

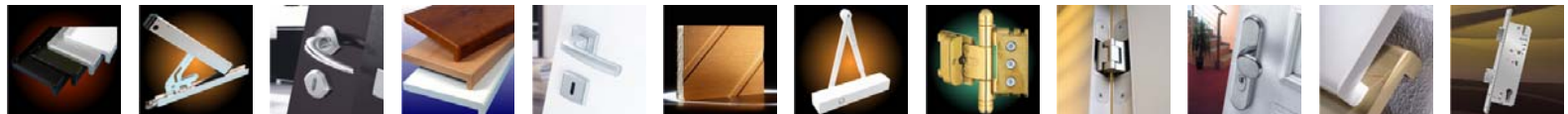
(208/ 5)
MARSEILLE
86G/3331/3310/1138

(208/ 6)



BEZPEČNOSTNÍ KOVÁNÍ - NÁKRESY

Hliník

Nerez

Mosaz

Plast

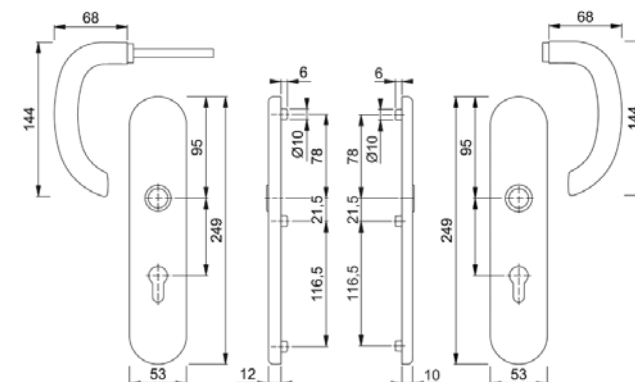
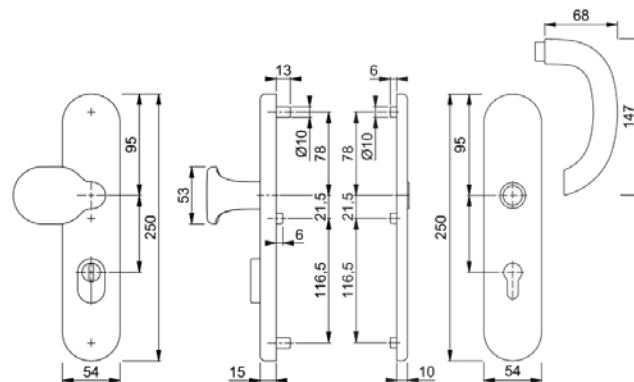
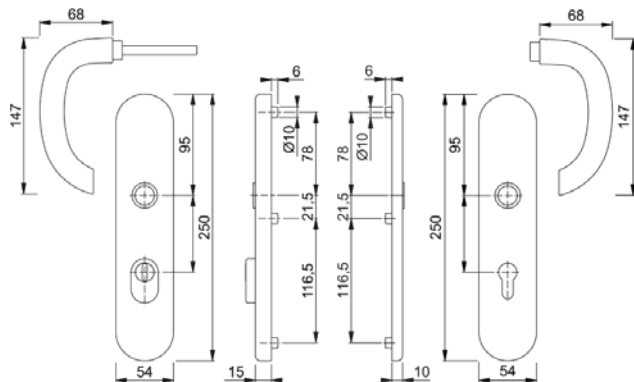

MARSEILLE
1138/3332ZA/3310

(209/ 1)

MARSEILLE
86G/3332ZA/3310/1138

(209/ 2)

MARSEILLE
E1138Z/3331/3310

(209/ 3)

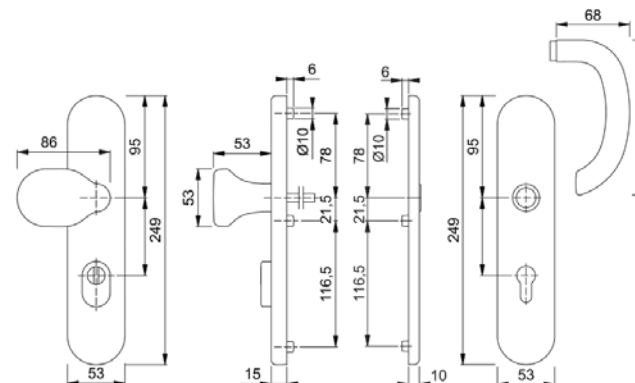
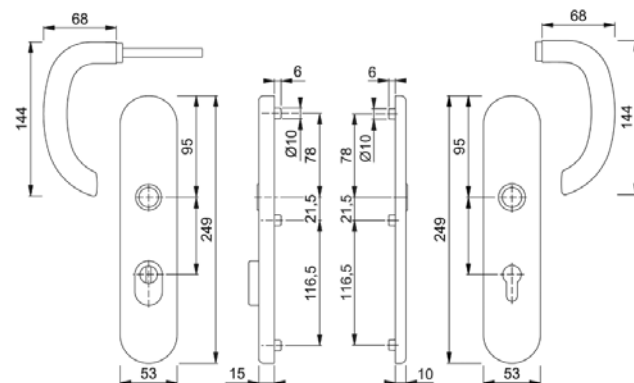
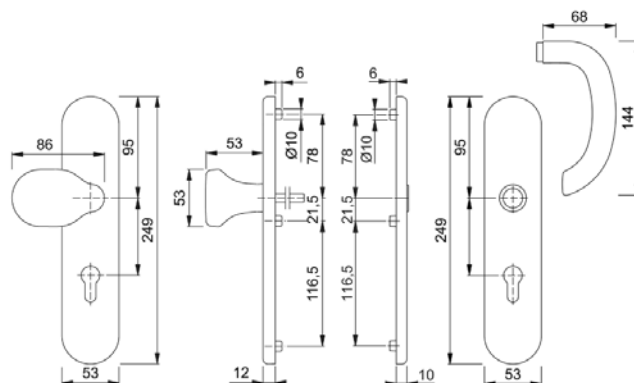

MARSEILLE
E86G/3331/3310/1138Z

(209/ 4)

MARSEILLE
E1138Z/3332ZA/3310/1138Z

(209/ 5)

MARSEILLE
E86G/3332ZA/3310/1138Z

(209/ 6)

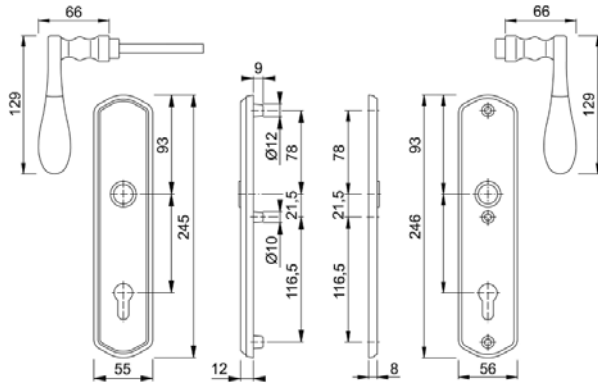

BEZPEČNOSTNÍ KOVÁNÍ - NÁKRESY
Hliník
Nerez
Mosaz
Plast

MÜNCHEN

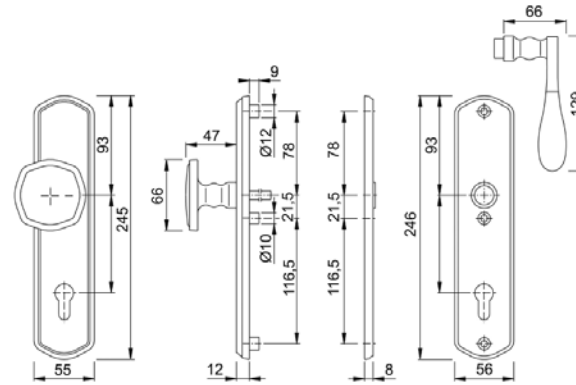
M112SH/334A/333N

(210/ 1)

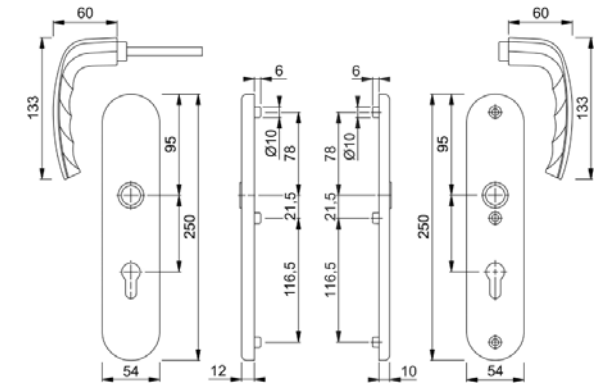
MÜNCHEN

M57/334A/333N/112

(210/ 2)

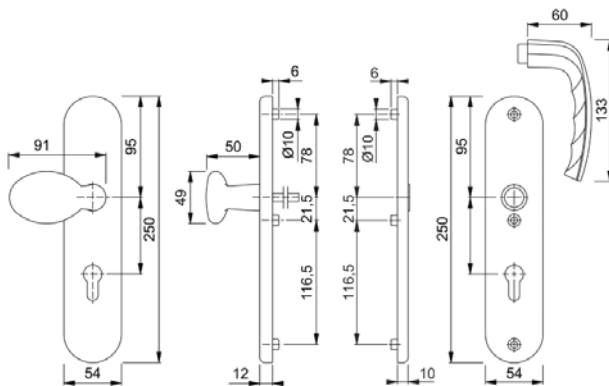
NEW YORK

1810H/3331/3410

(210/ 3)

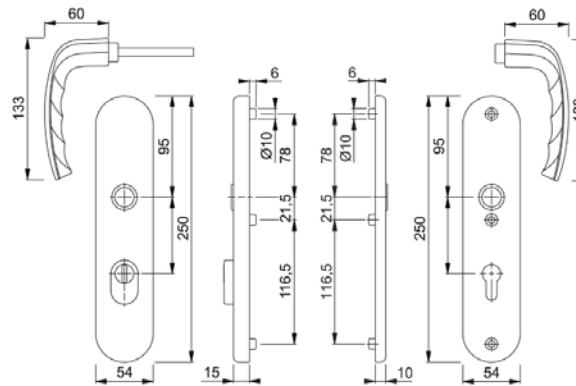
NEW YORK

76G/3331/3410/1810H

(210/ 4)

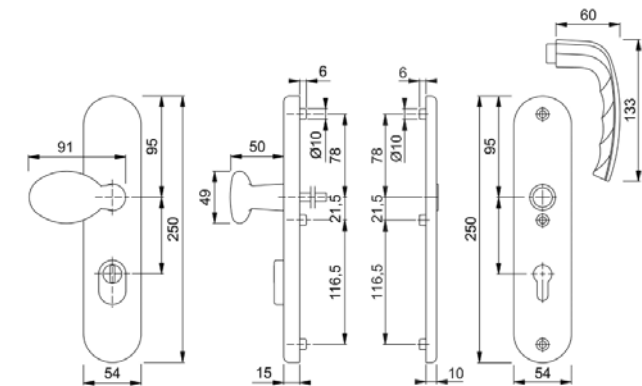
NEW YORK

1810H/3332ZA/3410

(210/ 5)

NEW YORK

76G/3332ZA/3410/1810H

(210/ 6)

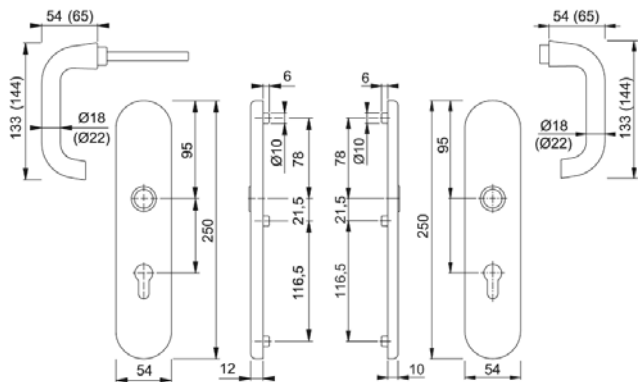

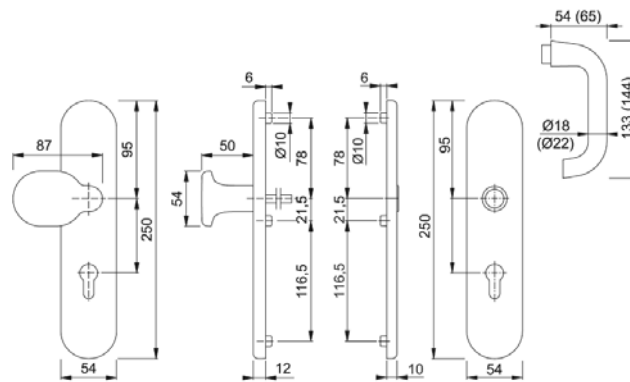
BEZPEČNOSTNÍ KOVÁNÍ - NÁKRESY
Hliník
Nerez
Mosaz
Plast

PARIS
138L/3331/3310

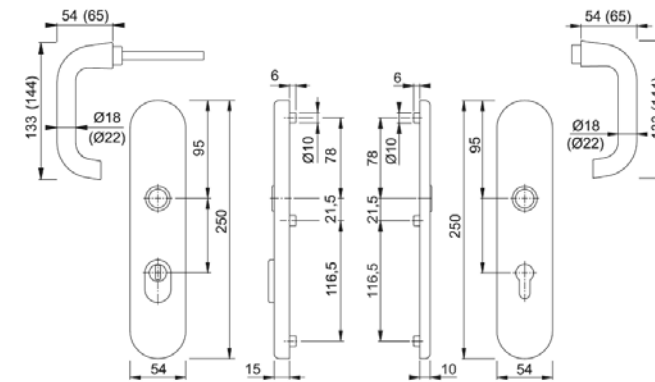
(211 / 1)

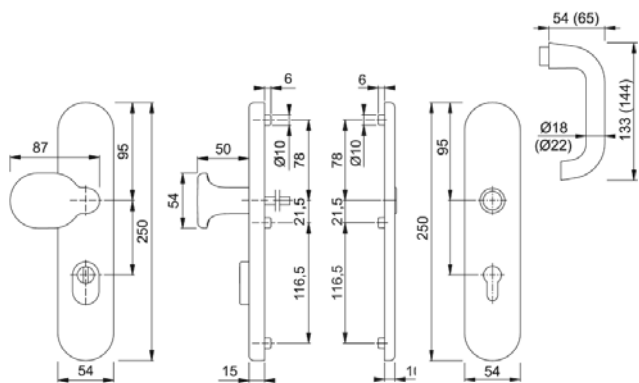
PARIS
86G/3331/3310/138L

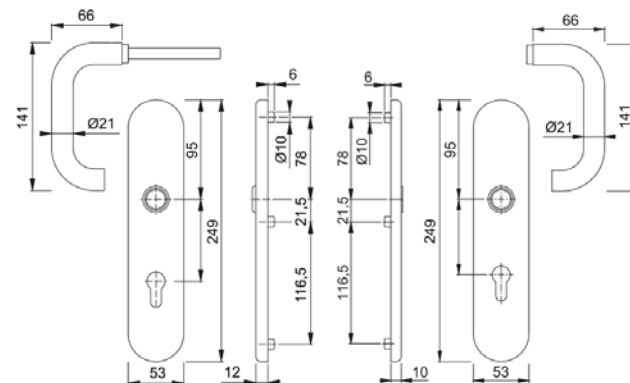
(211 / 2)

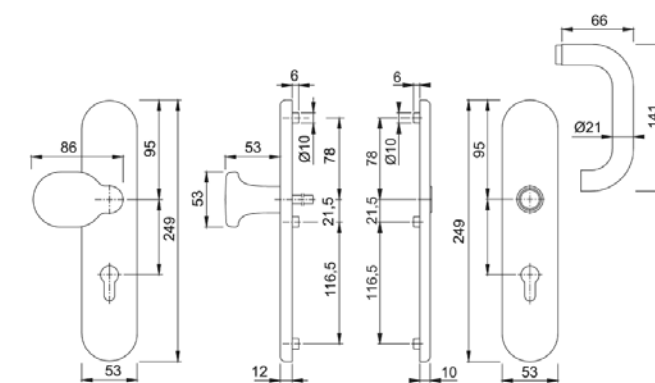
PARIS
138L/3332ZA/3310

(211 / 3)

PARIS
86G/3332ZA/3310/138L

(211 / 4)

PARIS
E138Z/3331/3310

(211 / 5)

PARIS
E86G/3331/3310/138Z

(211 / 6)



R.S.P. s.r.o.

BEZPEČNOSTNÍ KOVÁNÍ - NÁKRESY

Hliník

Nerez

Mosaz

Plast

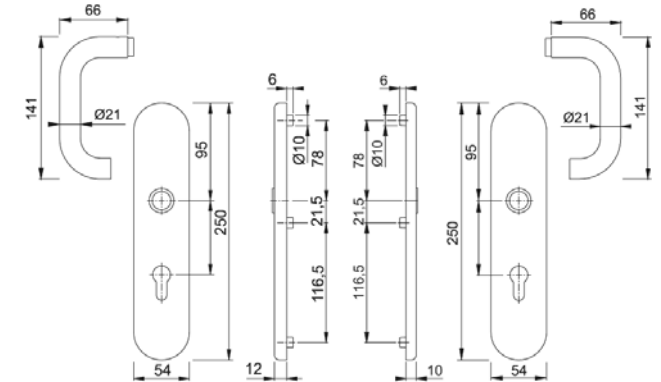
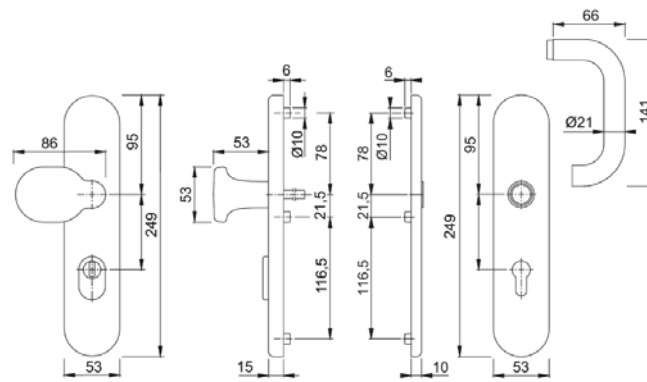
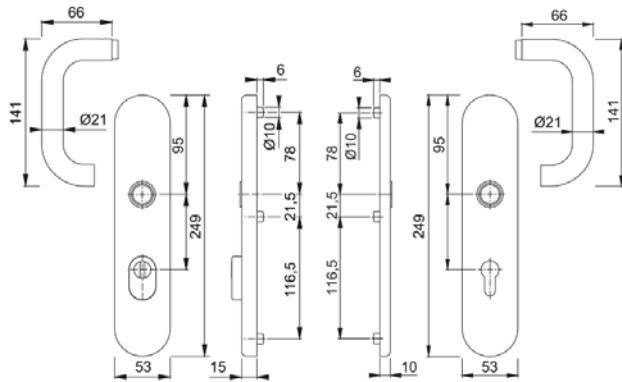

PARIS
E138Z/3332ZA/3310

(212/ 1)

PARIS
E86G/3332ZA/3310/138Z

(212/ 2)

PARIS
M138Z/3331/3310

(212/ 3)

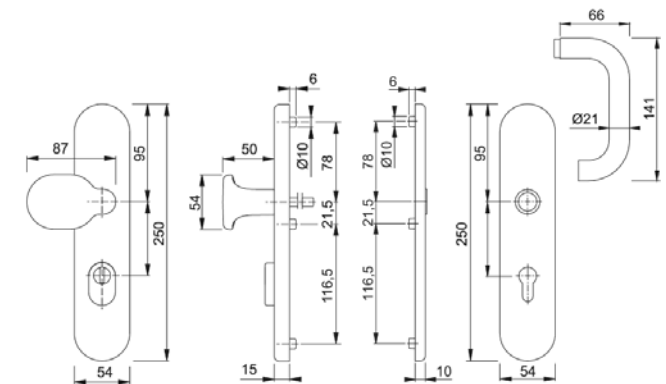
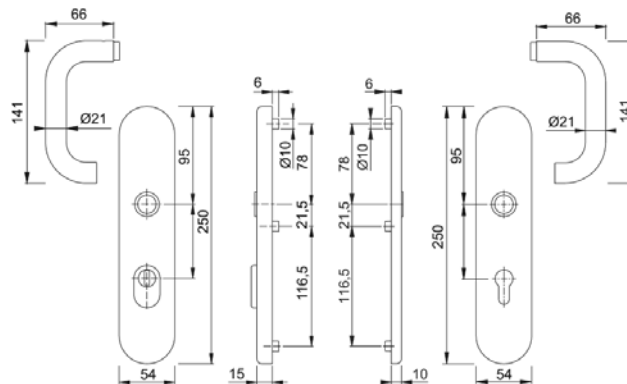
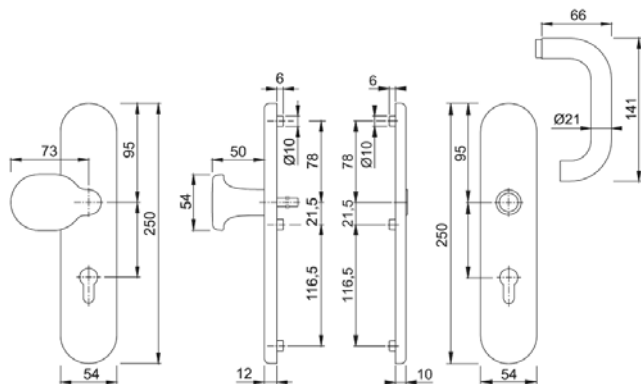

PARIS
M86G/3331/3310/138Z

(212/ 4)

PARIS
M138Z/3332ZA/3310

(212/ 5)

PARIS
M86G/3332ZA/3310/138Z

(212/ 6)

© R.S.P. s.r.o. Týn nad Vltavou

Verze: HOP-SP-06.14

Platnost od: 15.03.2014

Tisk: 01.03.2014

Technické změny vyhrazeny!

212





BEZPEČNOSTNÍ KOVÁNÍ - NÁKRESY

Hliník

Nerez

Mosaz

Plast

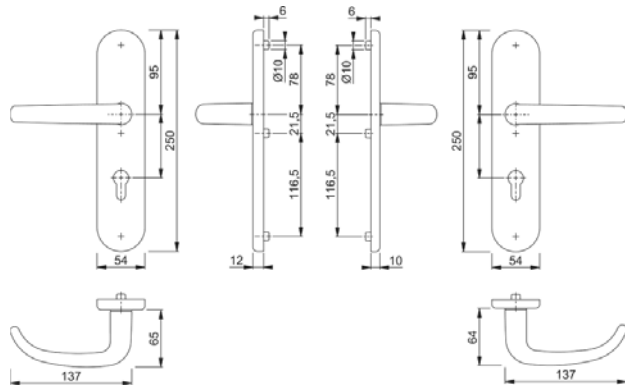

SAN FRANCISCO

(213/ 1)

1301/3331/3310

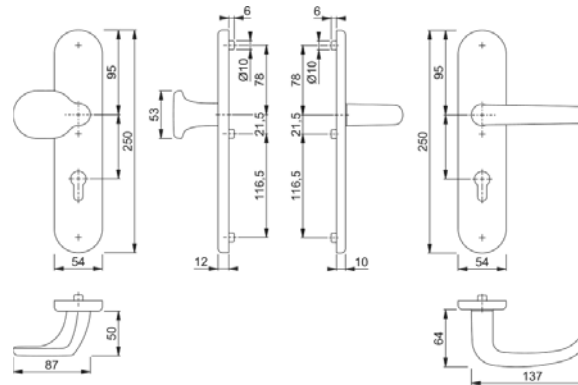

SAN FRANCISCO

(213/ 2)

86G/3331/3310/1301

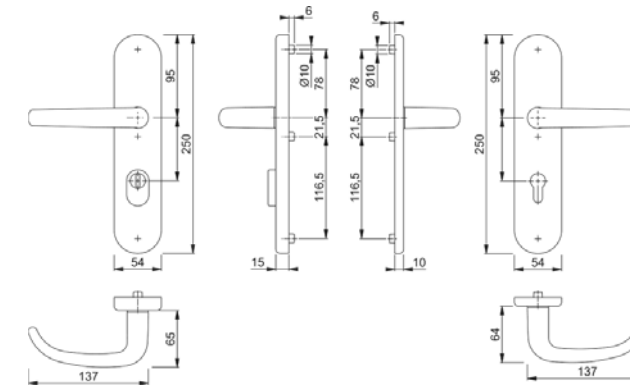

SAN FRANCISCO

(213/ 3)

1301/3332ZA/3310

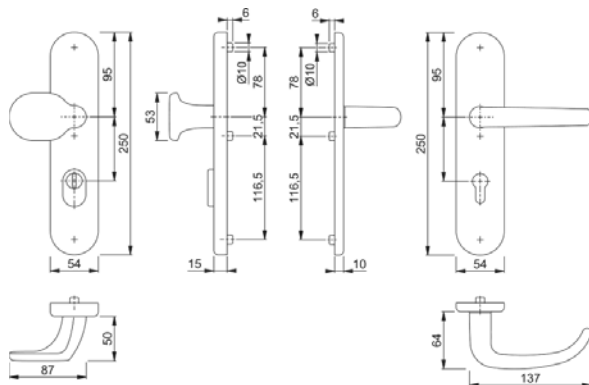

SAN FRANCISCO

(213/ 4)

86G/3332ZA/3310/1301

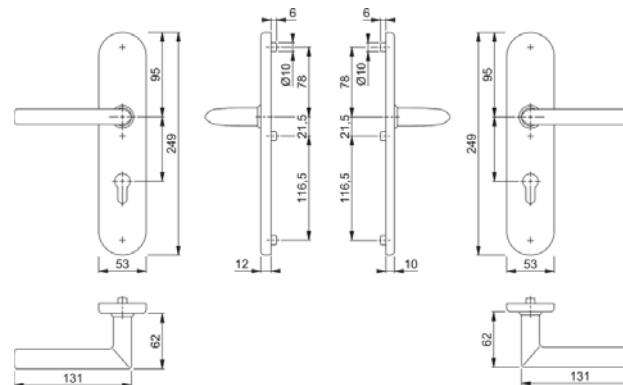

STOCKHOLM

(213/ 5)

E1140Z/3331/3310

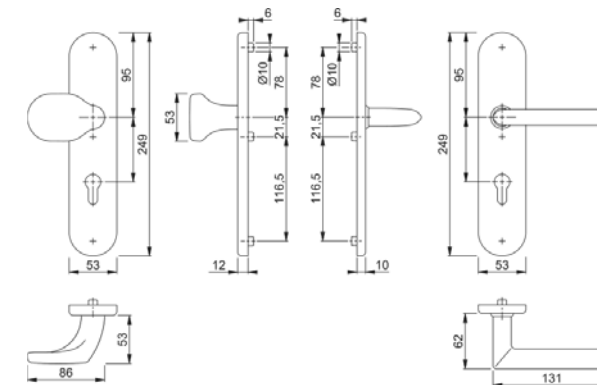

STOCKHOLM

(213/ 6)

E86G/3331/3310/1140Z





R.S.P. s.r.o.

BEZPEČNOSTNÍ KOVÁNÍ - NÁKRESY

Hliník

Nerez

Mosaz

Plast

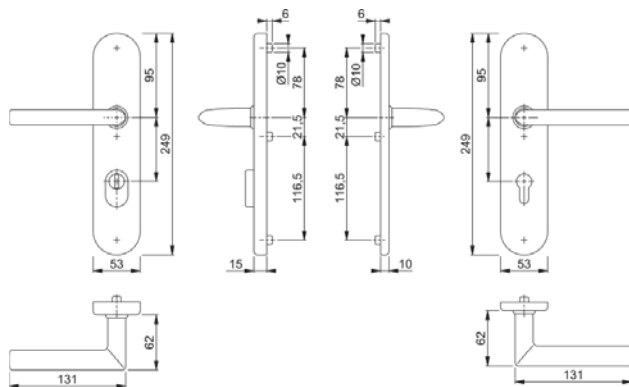

STOCKHOLM
E1140Z/3332ZA/3310

(214/ 1)

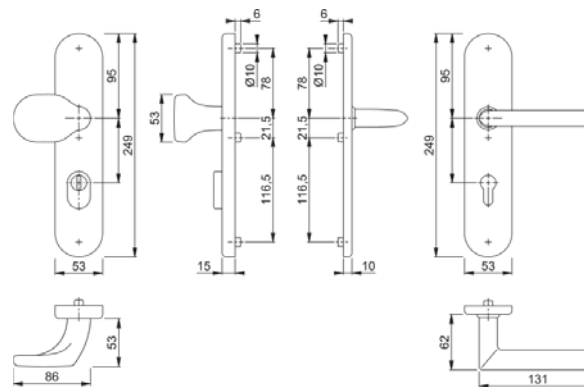

STOCKHOLM
E86G/3332ZA/3310/1140Z

(214/ 2)

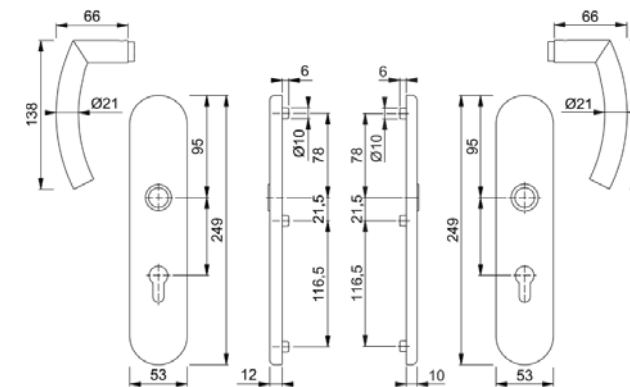

TRONDHEIM
E1430Z/3331/3310

(214/ 3)

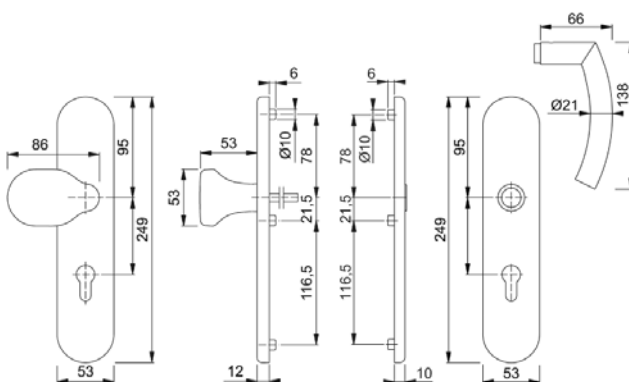

TRONDHEIM
E86G/3331/3310/1430Z

(214/ 4)

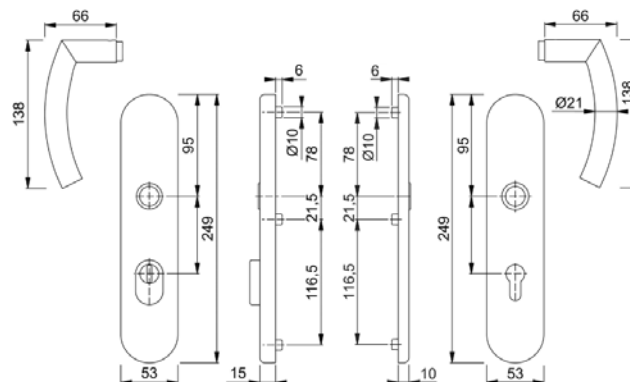

TRONDHEIM
E1430Z/3332ZA/3310

(214/ 5)

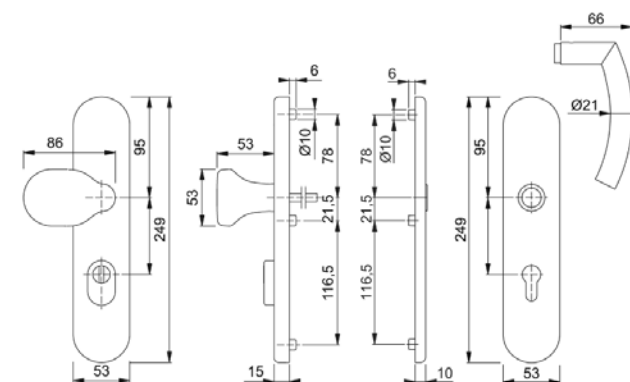

TRONDHEIM
E86G/3332ZA/3310/1430Z

(214/ 6)

© R.S.P. s.r.o. Týn nad Vltavou

Verze: HOP-SP-06.14

Platnost od: 15.03.2014

Tisk: 01.03.2014

Technické změny vyhrazeny!

214





BEZPEČNOSTNÍ KOVÁNÍ - NÁKRESY

Hliník

Nerez

Mosaz

Plast

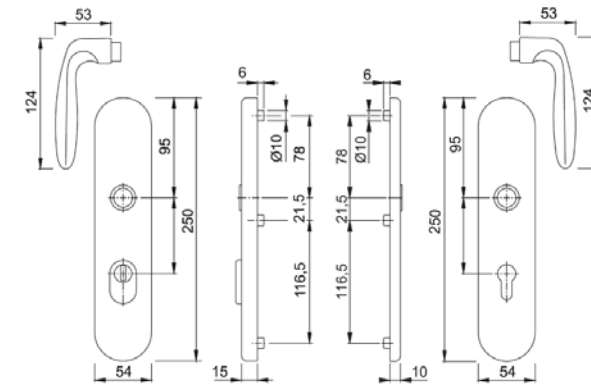
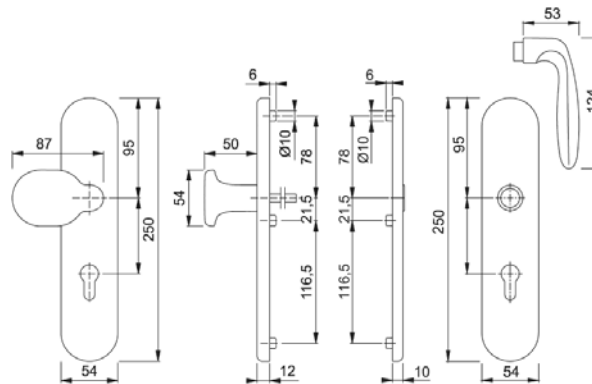
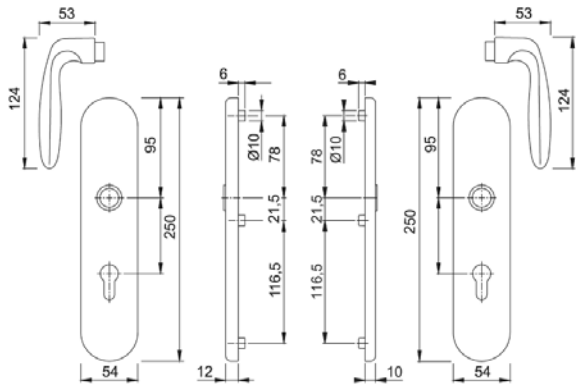

VERONA
1510/3331/3310

(215/ 1)

VERONA
86G/3331/3310/1510

(215/ 2)

VERONA
1510/3332ZA/3310

(215/ 3)

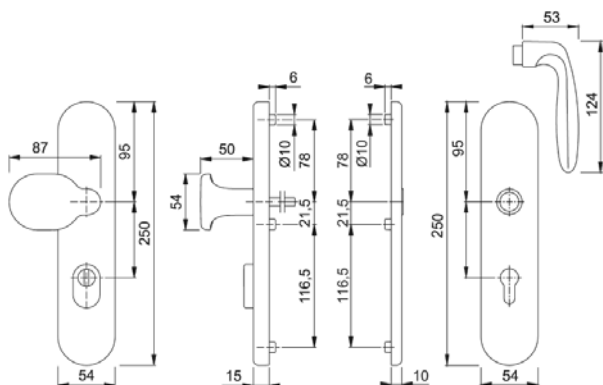

VERONA
86G/3332ZA/3310/1510

(215/ 4)

VERONA
E1800Z/3331/3310

(215/ 5)

VERONA
E86G/3331/3310/1800Z

(215/ 6)

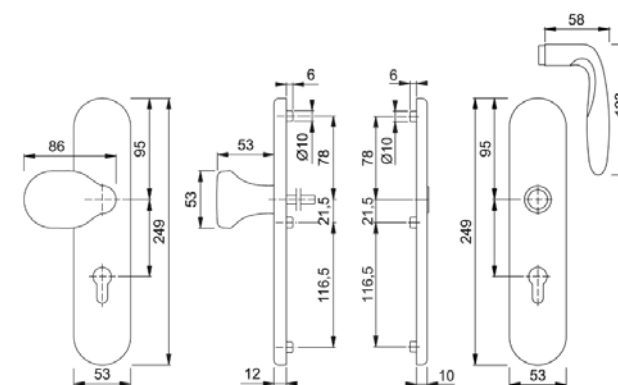
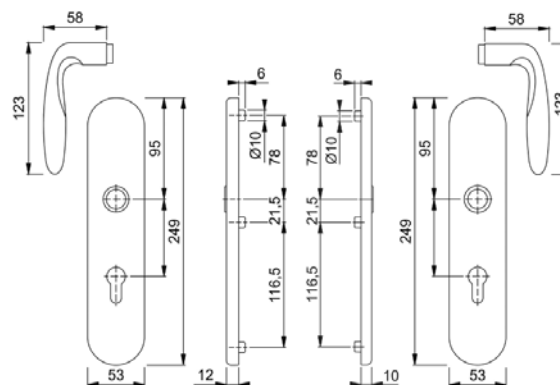



R.S.P. s.r.o.

BEZPEČNOSTNÍ KOVÁNÍ - NÁKRESY

Hliník

Nerez

Mosaz

Plast

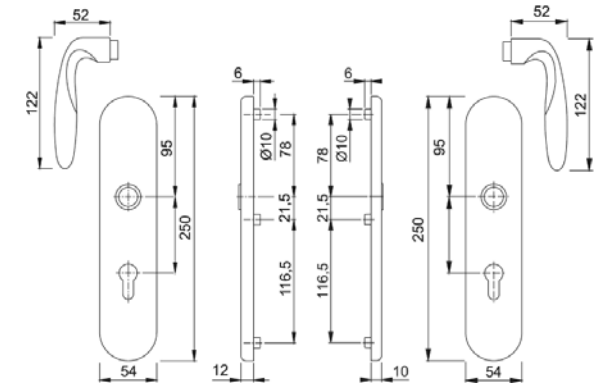
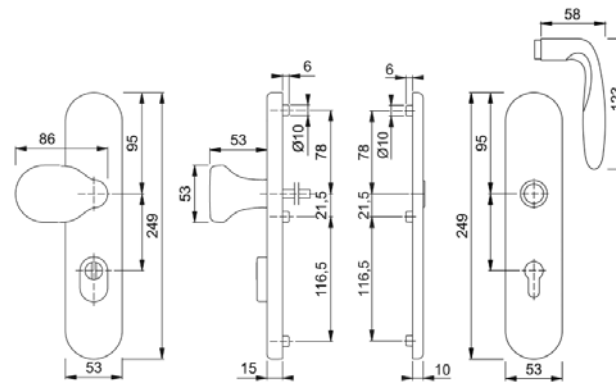
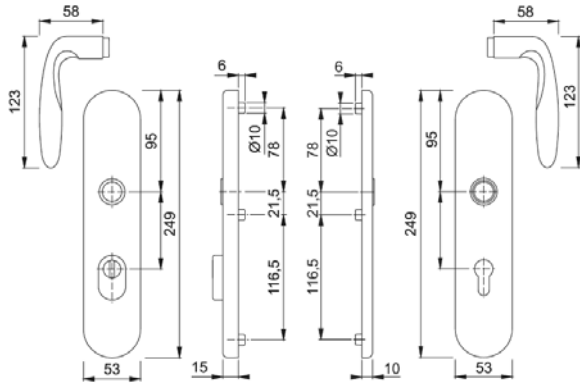

VERONA
E1800Z/3332ZA/3310

(216/ 1)

VERONA
E86G/3332ZA/3310/1800Z

(216/ 2)

VERONA
M151/3331/3310

(216/ 3)

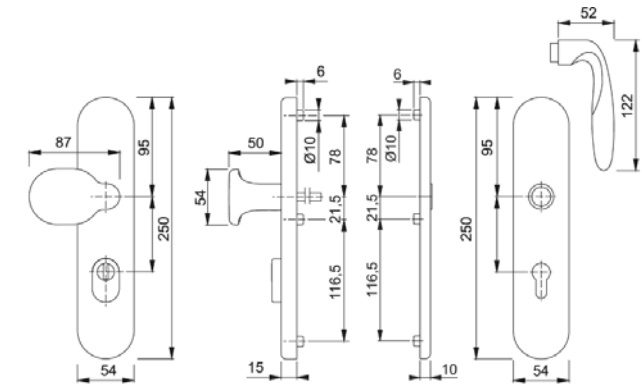
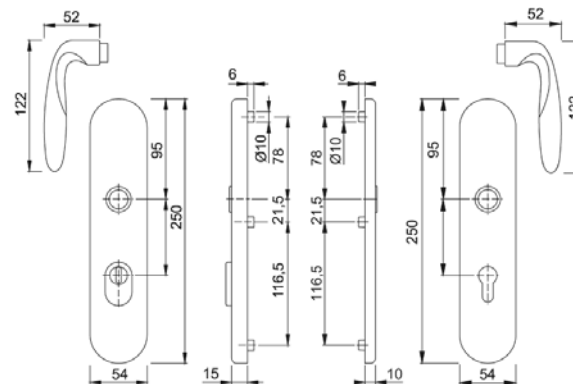
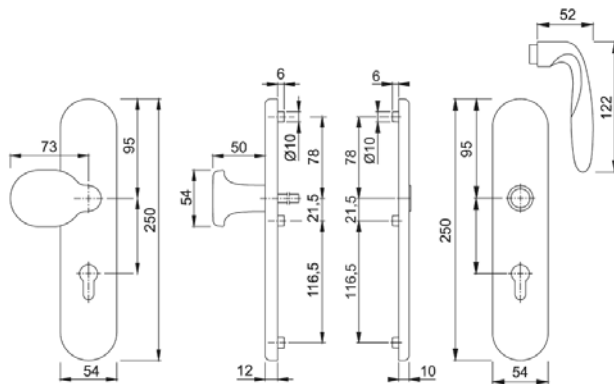

VERONA
M86G/3331/3310/151

(216/ 4)

VERONA
M151/3332ZA/3310

(216/ 5)

VERONA
M86G/3332ZA/3310/151

(216/ 6)

© R.S.P. s.r.o. Týn nad Vltavou

Verze: HOP-SP-06.14

Platnost od: 15.03.2014

Tisk: 01.03.2014

Technické změny vyhrazeny!

216

